

TA-AX44

US Model
Canadian Model
AEP Model
UK Model
E Model

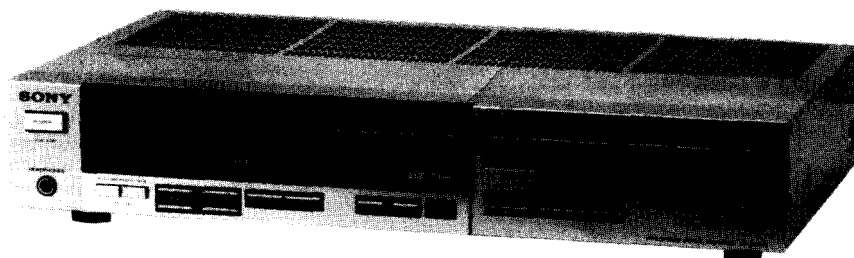

INTEGRATED STEREO AMPLIFIER

SPECIFICATIONS

GENERAL

- System:** Preamplifier section: low-noise IC equalizer amp.; ASP tone control
Power amplifier section: pure-complementary SEPP OCL power amplifier with all stages direct coupled
- Power Requirements:** US, Canadian model: 120 V ac, 60 Hz
AEP model: 220 V ac (240 V ac adjustable by authorized Sony personnel), 50/60 Hz
UK model: 240 V ac (220 V ac adjustable by authorized Sony personnel), 50/60 Hz
E model: 120, 220 or 240 V ac adjustable, 50/60 Hz
- Power Consumption:** US, AEP model: 100 watts
Canadian model: 155 watts
UK model: 270 watts
E model: 100 watts
- AC Outlets:** AEP, UK model: 3 switched, total 100 watts max.
US, Canadian model:
Two switched (total 100 watts)
One unswitched (100 watts)
E model: 2 switched, total 100 watts max.
1 unswitched, 100 watts max.
- Dimensions:** Approx. 430 x 80 x 290 mm (w/h/d)
(17 x 3 1/4 x 11 1/4 inches)
including projecting parts and controls

Weight: Approx. 5.6 kg (12 lbs 6 oz) net
Approx. 6 kg (13 lbs 4 oz) in shipping carton

AMPLIFIER SECTION

POWER OUTPUT AND TOTAL HARMONIC DISTORTION: (US, Canadian model)

With 8 ohm loads, both channels driven, from 20 - 20,000 Hz; rated 40 watts per channel minimum RMS power, with no more than 0.008% total harmonic distortion from 250 milliwatts to rated output.

— Continued on page 2 —

SAFETY-RELATED COMPONENT WARNING!!

COMPONENTS IDENTIFIED BY SHADING AND MARK  ON THE SCHEMATIC DIAGRAMS, EXPLODED VIEWS AND IN THE PARTS LIST ARE CRITICAL TO SAFE OPERATION. REPLACE THESE COMPONENTS WITH SONY PARTS WHOSE PART NUMBERS APPEAR AS SHOWN IN THIS MANUAL OR IN SUPPLEMENTS PUBLISHED BY SONY.

ATTENTION AU COMPOSANT AYANT RAPPORT
À LA SÉCURITÉ!

LES COMPOSANTS IDENTIFIÉS PAR UNE TRAME ET UNE MARQUE  SUR LES DIAGRAMMES SCHEMATIQUES, LES VUES ÉCLATÉES ET LA LISTE DES PIÈCES SONT CRITIQUES POUR LA SÉCURITÉ DE FONCTIONNEMENT. NE REMPLACER CES COMPOSANTS QUE PAR DES PIÈCES SONY DONT LES NUMÉROS SONT DONNÉS DANS CE MANUEL OU DANS LES SUPPLÉMENTS PUBLIÉS PAR SONY.



S O N Y
SERVICE MANUAL

Continuous RMS Power Output (Less than 0.688% THD, both channels driven simultaneously) (AEP, UK, E model):

At 20 Hz – 20 kHz
40 + 40 watts (8 ohms)
At 1 kHz
44 + 44 watts (8 ohms)
According to DIN 45500
40 + 40 watts (8 ohms)

Power Bandwidth (IHF): 5 Hz – 45 kHz
Dynamic Headroom: 1.8 dB ('78 IHF)
Harmonic Distortion: Less than 0.008% at rated output
Intermodulation (IM) Distortion (60 Hz: 7 kHz = 4 : 1): Less than 0.008% at rated output
Frequency Response: PHONO: RIAA equalization curve ± 0.5 dB
TUNER
DAD/AUX 10 Hz – 120 kHz $+0$ dB
TAPE 1.2 -3.0 dB
Residual Noise: Less than $35\mu\text{V}$ (8 ohms, network A)
Damping Factor: 50 (8 ohms, 1 kHz)

Inputs:

	Sensitivity	Impedance	Maximum input capability (1 kHz)	SIN (weighting network, input level)
PHONO	2.5 mV	50 k Ω	150 mV	76 dB 80 dB* (A, 2.5 mV)
TUNER DAD/AUX TAPE 1, 2	150 mV	50 k Ω	—	102 dB 90 dB* (A, 150 mV)

* '78 IHF

outputs: REC OUT 1, 2
Voltage 150 mV
Impedance 4.7 k ohms
SPEAKER A, B
Accepts speakers of 8 – 16 ohms.
HEADPHONES
Accepts low and high impedance headphones.
Tone Controls: BASS
 ± 10 dB at 100 Hz (turnover freq. 500 Hz)
TREBLE
 ± 10 dB at 10 kHz (turnover freq. 2 kHz)
Subsonic Filter: 6 dB/octave attenuation below 15 Hz
High Filter: 6 dB/octave attenuation above 9 kHz
Muting: -20 dB

0 dB = 0.775 V

FEATURES

The TA-AX44 integrated stereo amplifier incorporates a number of technical breakthroughs in circuit design. On its attractive front panel most of the controls and switches are "touch pad" switches and the tone, filter and volume settings are shown by fluorescent displays.

HIGHLIGHTS OF THE TA-AX44'S CIRCUIT

ASP (Audio Signal Processor) IC in the preamplifier stage
Sony has developed a new audio device, called the Audio Signal Processor IC, which can digitally control the tone, filter and volume settings. The ASP IC also permits electronic program source selection. Mechanical controls and switches have been practically eliminated from the front panel. In combination with a microcomputer and a non-volatile memory IC, the ASP IC offers greater flexibility — an Acoustic Function, an ability to store and recall two sets of tonal adjustments.

Legato linear power amplifier stage

The operation of the power amplifier stage is stable without any observable distortion up through the higher frequencies. We call this power amp "Legato Linear" because its switching distortion is very low and its output waveform smooth.

Simple, straight signal path layout

A heat-pipe cooling system and the ASP IC layout near the input and output terminals minimize wiring losses and allow low distortion operation.

Wireless remote control operation

Using the optional RM-44 system remote controller, various operations — power on/off, program selection, acoustic setting selection, muting on/off and volume adjustment — can be remotely controlled.

OPERATING VOLTAGE

Before connecting the unit to the power source, check that the operating voltage of your unit is the same as the local power line voltage.

The Continental European model (AEP model) operates on 220 V ac (or 240 V ac adjustable by authorized Sony personnel).

The United Kingdom model (UK model) operates on 240 V ac (or 220 V ac adjustable by authorized Sony personnel).

The model for other countries (E model) operates on either 120, 220 or 240 V ac. The voltage selector is located on the rear panel. If the selector must be reset, disconnect the ac power cord and turn the selector with a coin so that the arrow mark of the selector points to the proper voltage figure.

The US, Canadian model operates on 120 V ac.

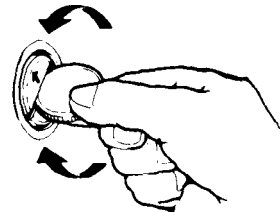

PRECAUTIONS

On safety

- Check that the operating voltage of your unit is identical with the voltage of your local power supply.
- Should any liquid or solid object fall into the cabinet, unplug the unit and have it checked by qualified personnel before operating it any further.
- Unplug the unit from the wall outlet if it is not to be used for an extended period of time. To disconnect the cord, pull it out by grasping the plug. Never pull the cord itself.

On installation

- Do not install the unit in a location near heat sources such as radiators or air ducts, or in a place subject to direct sunlight, excessive dust, mechanical vibration or shock.
- Good air circulation is essential to prevent internal heat build-up in the unit. Place the unit in the location with adequate air circulation. Do not place the unit on a soft surface, such as a rug that would block the ventilation holes on the bottom.
- DO NOT place anything on top of the cabinet. The top ventilation holes must be unobstructed for the proper operation of the unit and to prolong the life of its components.

On operation

- Before making program source connections, be sure to turn the power switch off and unplug the unit.
- Do not attempt to test the protection circuits by blocking the ventilation holes or connecting improper loads.
- When the unit is not used, turn the power off, to conserve energy and to extend the useful life of your unit.

On cleaning the cabinet

Clean the cabinet, panel and controls with a soft cloth lightly moistened with mild detergent solution. Do not use any type of abrasive pad, scouring powder or solvent such as alcohol or benzene.

On repacking

Do not throw away the carton and the packing material. It makes an ideal container to transport the unit in. When shipping the unit for repair work or to another location, repack it as illustrated on the carton box.

MODEL IDENTIFICATION

— Specification Label —

[AEP model]

SONY [®] MODEL NO. TA-AX44	
INTEGRATED STEREO AMPLIFIER AC 220V ~ 50/60Hz 100W	
	
SERIAL NO.	
MADE IN JAPAN	

[UK model]

SONY [®] MODEL NO. TA-AX44	
INTEGRATED STEREO AMPLIFIER AC: 240V ~ 50/60Hz 270W	
	
SERIAL NO.	
MADE IN JAPAN	

[US, Canadian model]

SONY [®] MODEL NO. TA-AX44	
INTEGRATED STEREO AMPLIFIER AC: 120V ~ 60Hz 100W	
	
SERIAL NO.	
MADE IN JAPAN	

LOCATION AND FUNCTION OF CONTROLS

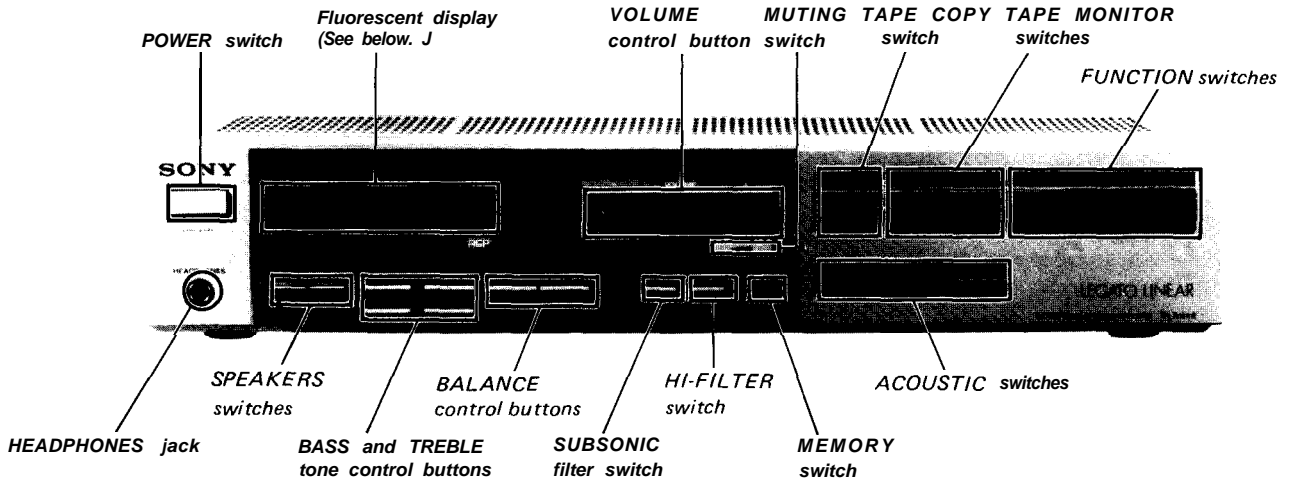

Fluorescent display section

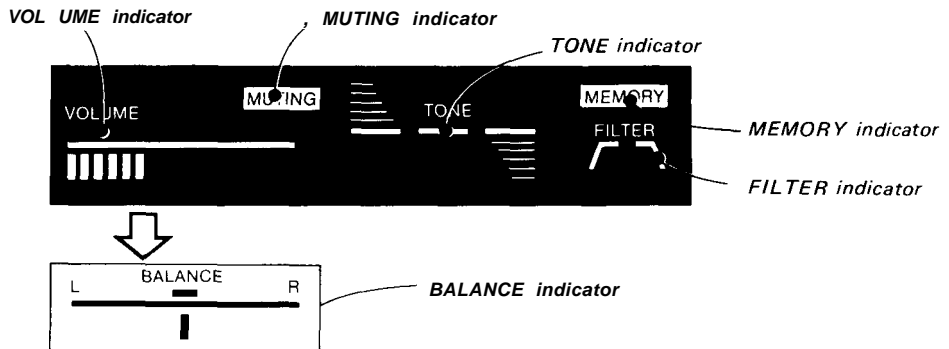

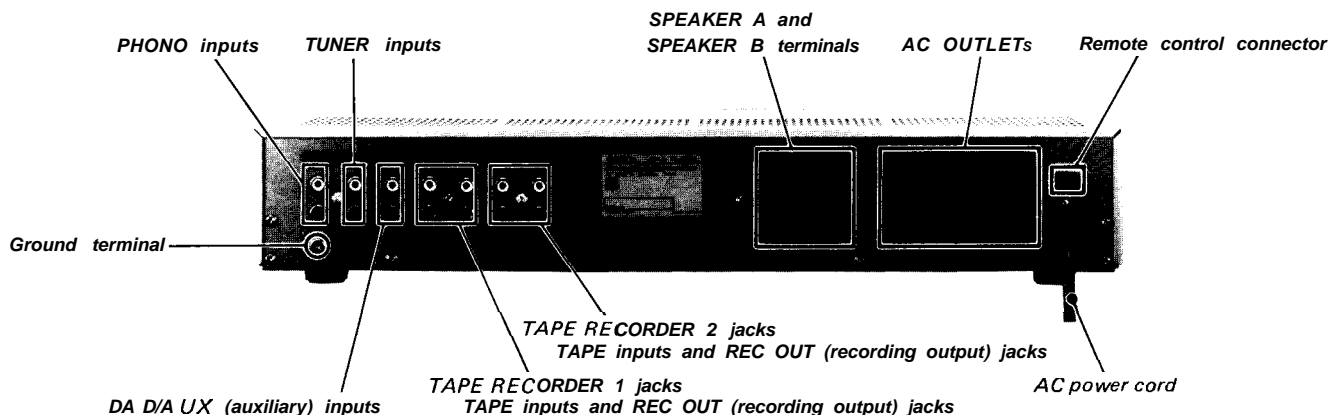

Photo: AEP, UK model

AC outlets

These are used to power other audio components whose power consumption is less than the wattage indicated below the ac outlet.

The SWITCHED outlet is controlled by the front panel POWER switch.

The UNSWITCHED outlet (only on the E model) is not controlled by the POWER switch.

Do not connect any electrical home appliance such as an electric iron, fan, TV or other high-wattage equipment to these ac outlets.

The four groups of ac power cord plugs and ac outlets on your amplifier rear panel are illustrated below

	Power cord plug	AC outlet
AEP model (available in Continental European countries)		SWITCHED TOTAL 100 W MAX
UK model (available in the UK)		SWITCHED TOTAL 100 W MAX*
US, Canadian, E model (available in other countries)	Plug adaptor** (supplied)	UNSWITCHED 100 W MAX SWITCHED TOTAL 100 W
	Group A (E model only)	
Group B (US, Canadian, E model)		

* The ac outlet on the amplifier can supply ac power to the following components :

- Tuner ST-JX44L, ST-JX-22L
- Turntable PS-LX33, PS-LX5
- Tape deck TC-FX500R, TC-FX44

**Use the plug adaptor to connect the amplifier to an ac outlet in the house. However, when making power connections among the Sony components, this adaptor is not needed

For the Customers in the United Kingdom

The mains lead plug of your apparatus is a 3-pin type especially designed to be connected only to the Sony RM-44 system remote controller. The remote controller has a receptacle on the rear to receive this plug to supply mains power to other components of your audio system.

To connect the apparatus directly to a mains power point in your house, firmly insert the 3-pin plug into the supplied mains lead adaptor.

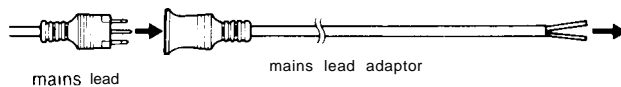

CAUTION

Connect the 3-pin plug only to the mains outlet on the component mentioned above or to the supplied mains lead adaptor.

-Important

The wires in this mains lead adaptor are coloured in accordance with the following code.

- Blue : Neutral
- Brown : Live

As the colours of the wires in the mains lead adaptor of this apparatus may not correspond with the coloured markings identifying the terminals in your plug, proceed as follows :
The wire which is coloured blue must be connected to the terminal which is marked with the letter N or coloured black.
The wire which is coloured brown must be connected to the terminal which is marked with the letter L or coloured red.

OPERATION

TO GET SOUND

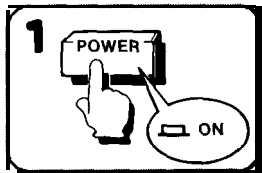

4 Adjust the volume.

VOLUME

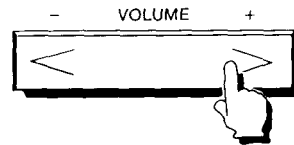

When the power is turned on, the volume will be automatically reset to minimum, then will be up slowly to the previous setting.

Press either end of the VOLUME control button when the volume is adjusted to your preference.

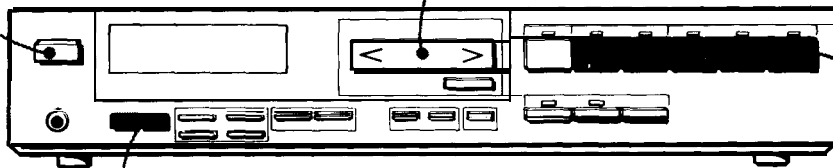

2

Select the speaker system used.

A-SPEAKERS-B



To drive speaker system A, depress A switch.
To drive speaker system B depress B switch.
To drive both speaker systems depress A and B switches.
For headphone listening only : keep both switches released

3

Select the program source and start the program.

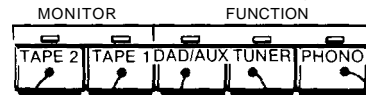

For the 'record program.

For the tuner program.

For auxiliary sources connected to the DAD/AUX jacks.

For the 'taped program

connected to the TAPE RECORDER 1 TAPE jacks

For the taped program, connected to the TAPE RECORDER 2 TAPE jacks.

Important points to remember

- The MONITOR switches have priority over the FUNCTION switches (PHONO, TUNER and DAD/AUX) when they are engaged at the same time.
- To disengage the MONITOR switch, press the same switch again.
- The TAPE COPY switch is a push-on/push-off switch, and does not affect any other FUNCTION or MONITOR switch.

SOUND ADJUSTMENTS

Stereo balance

The feeling of direction and depth that stereophonic sound produces is greatly diminished if the volume levels of the two channels are not balanced to produce a well-defined stereo image.

Adjust the BALANCE control buttons as necessary. Proper setting of the BALANCE control will vary with different program sources because of differences in recording levels. Stereo balance is also affected by the acoustics of the listening room, which itself is dependent on the shape and size of the room, the location of the room's furniture, and the carpet and wall coverings.

Tone

Use the tone control buttons to adjust the tone to suit the characteristics of the listening room and the program source. When listening to a program source with high-frequency noise, press the HI-FILTER switch.

If the woofer cones of the speaker system move a lot when a warped record is played, press the SUBSONIC filter switch to reduce the very low-frequency distortion caused by record warp.

The manipulation of the tone control section does not interrupt the signal path in the amplifier. However, its overuse may adversely affect amplifier tone quality.

TO SET THE ACOUSTIC SETTINGS

—Acoustic Function—

The TA-AX44 can store and recall the acoustic settings—tone control (BASS and TREBLE), and filters (SUBSONIC and HI-FILTER) used, thus instantly providing a choice of two different acoustic settings. These settings may be based upon the preferences of two individual users of the system, or the speaker system in use, or the type of music being listened to, etc.

- 1 Adjust the tonal quality to your preference.
- 2 Press the MEMORY switch. The MEMORY indicator will come on, during which time you should press either the ACOUSTIC 1 or 2 switch.

Now one of the two acoustic settings is committed to memory.

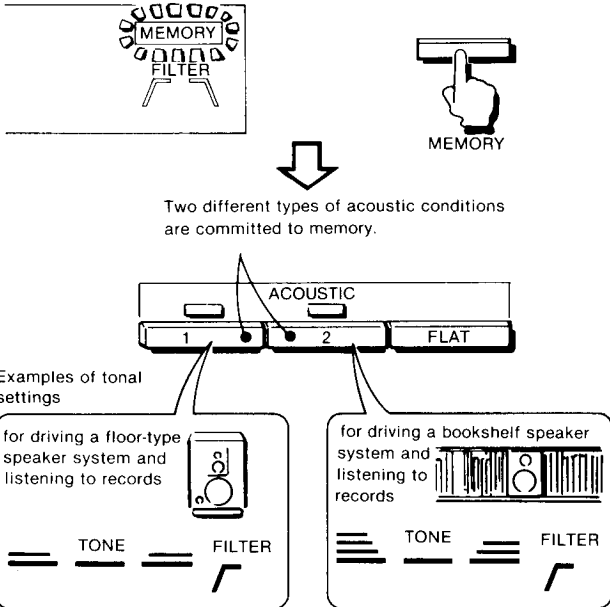

Q. How can I check the acoustic setting?

A. Once the setting is set, press the FLAT switch. All the acoustic settings are disengaged and a flat frequency response results. Then press the ACOUSTIC switch which you committed to memory, so that the original settings will be recalled. Now compare the effect of the settings with the flat frequency response.

Q. How can I change temporarily a part of the acoustic settings?

A. Simply change the part of the acoustic setting you want. You can recall the original settings later by pressing the ACOUSTIC switch.

Q. How can I change all the acoustic settings?

A. Simply set the new acoustic settings as you like and memorize them as described before.

Q. If I turn the amplifier off, are the acoustic settings cancelled?

A. No. The TA-AX44, with its non-volatile IC in the memory circuit, retains the contents of the memory even when the power is off, and recalls them whenever you want.

TAPE RECORDING AND TAPE COPY

TO RECORD

- 1 Select the program to be recorded with the FUNCTION switches.
- 2 Start the program and set the tape recorder in the record mode.

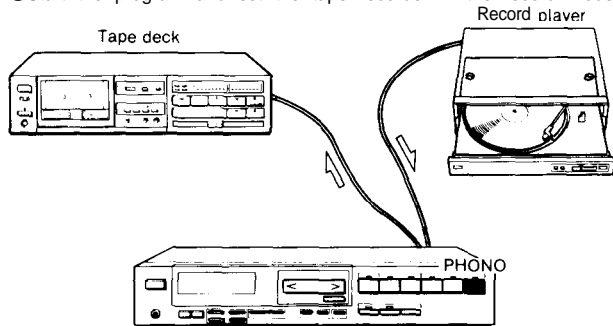

The filters, and tone and volume settings have no effect on recording.

Monitoring of a 3-head tape recorder

If your tape recorder has separate record and playback heads, you can monitor the recording results.

When the tape recorder used for recording is connected to the TAPE RECORDER 1 REC OUT jacks, press the TAPE 1 switch and you can monitor the recording results. Press the TAPE 1 switch again to disengage, and the source sound will be heard. Be sure to keep the monitor switch of the tape recorder in the TAPE position.

TO COPY

If you have two tape recorders, you can copy a taped program from tape recorder 1 (connected to TAPE RECORDER 1 TAPE inputs) to tape recorder 2 (connected to TAPE RECORDER 2 REC OUT outputs). Tape copy from tape recorder 2 to tape recorder 1 cannot be made.

You can copy a tape while listening to a record or a broadcast.

- 1 Insert the recorded tape into the tape recorder 1 and a blank tape into the tape recorder 2.
- 2 Press the TAPE COPY switch.
- 3 Adjust the recording level of tape recorder 2.

Start the playback of tape recorder 1 and the recording of tape recorder 2. Copying will begin.

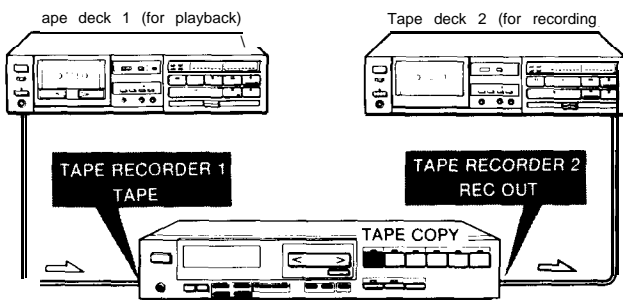

To listen to a program while the tape is being copied :

For the playback sound of tape recorder 1 : press the TAPE 1 switch.

For a program source connected to the PHONO, TUNER or DAD/AUX inputs : press the appropriate FUNCTION switch.

REMOTE CONTROL OPERATION WITH AN OPTIONAL REMOTE CONTROLLER

The optional RM-44 system remote controller controls the following functions of the amplifier: power on/off, program selection, acoustic setting selection, muting on/off, and volume adjustment. This remote controller, with its infrared ray sensor, can control connected components by an infrared ray transmitted from the RM-44C remote commander supplied with the system remote controller. For connections and operations, refer to the system remote controller's instruction manual.

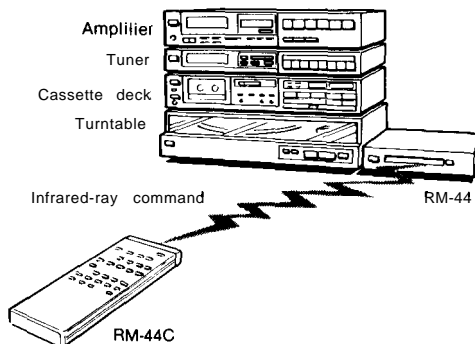

SECTION 1
OUTLINE

1-1. BLOCK DIAGRAM

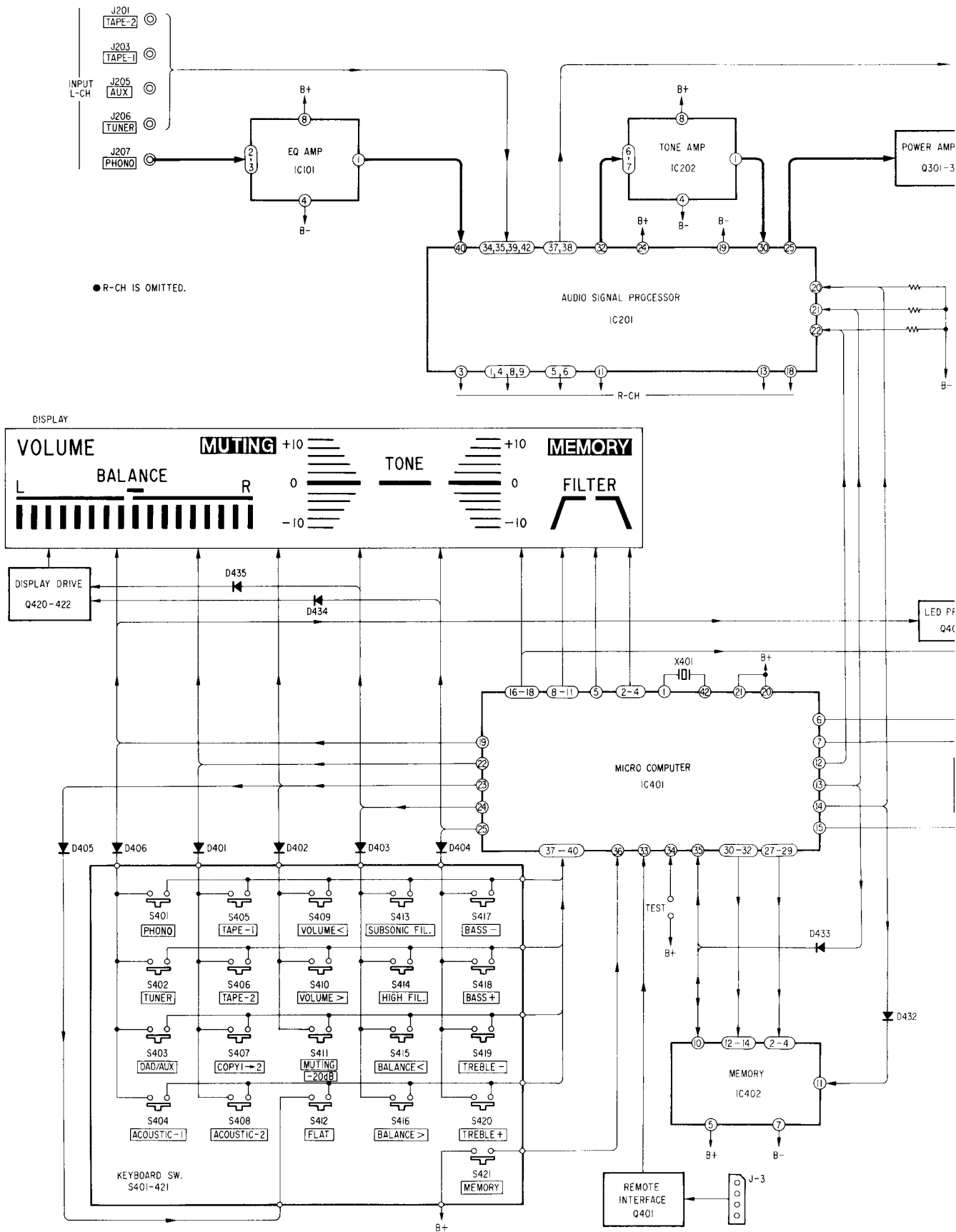

TAPE RECORDER 1,2
REC OUT

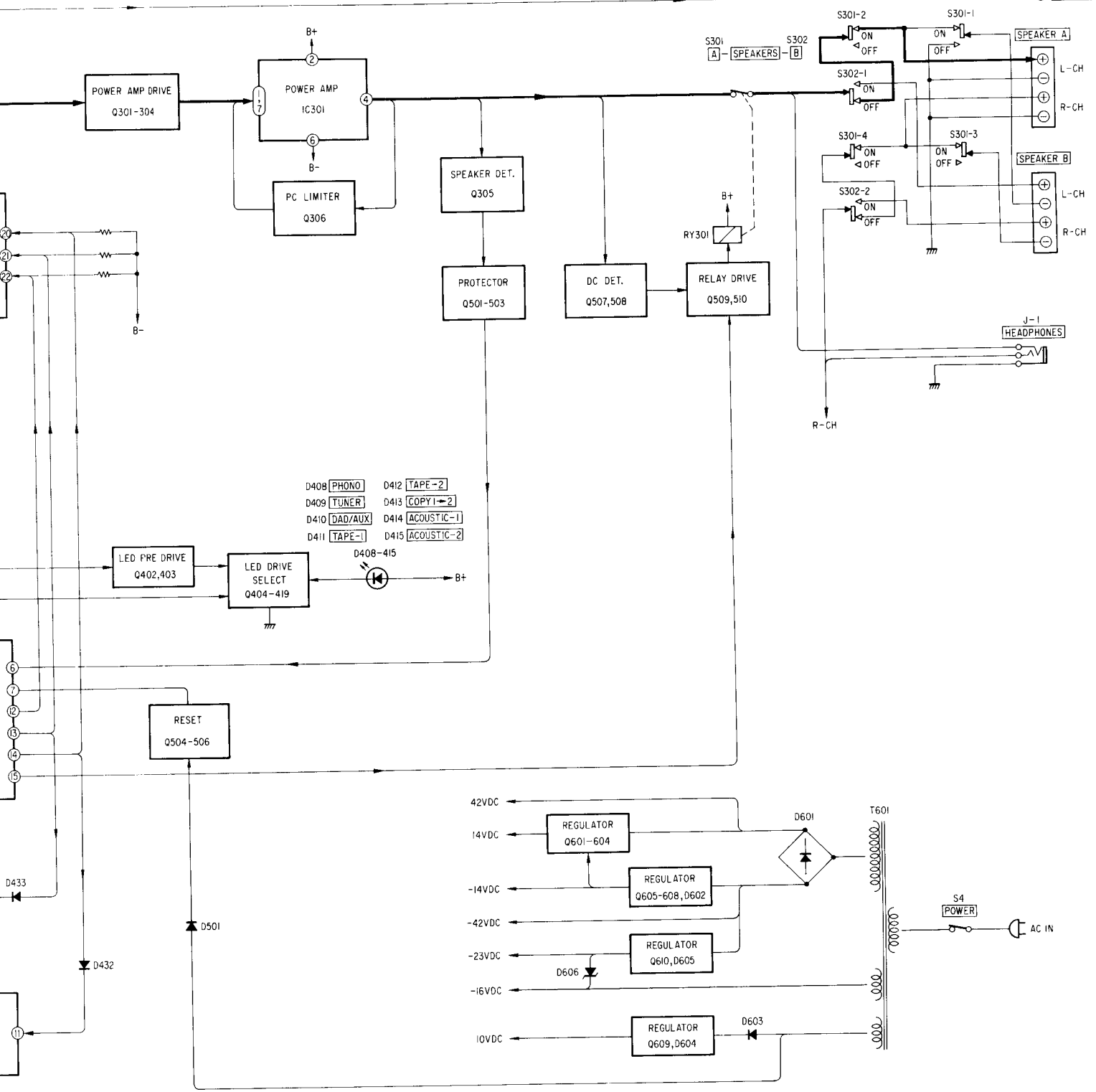

SECTION 2 DISASSEMBLY

2-1. DISASSEMBLY

Note: Follow the disassembly procedure in the numerical order given.

TOP COVER/BOTTOM PLATE

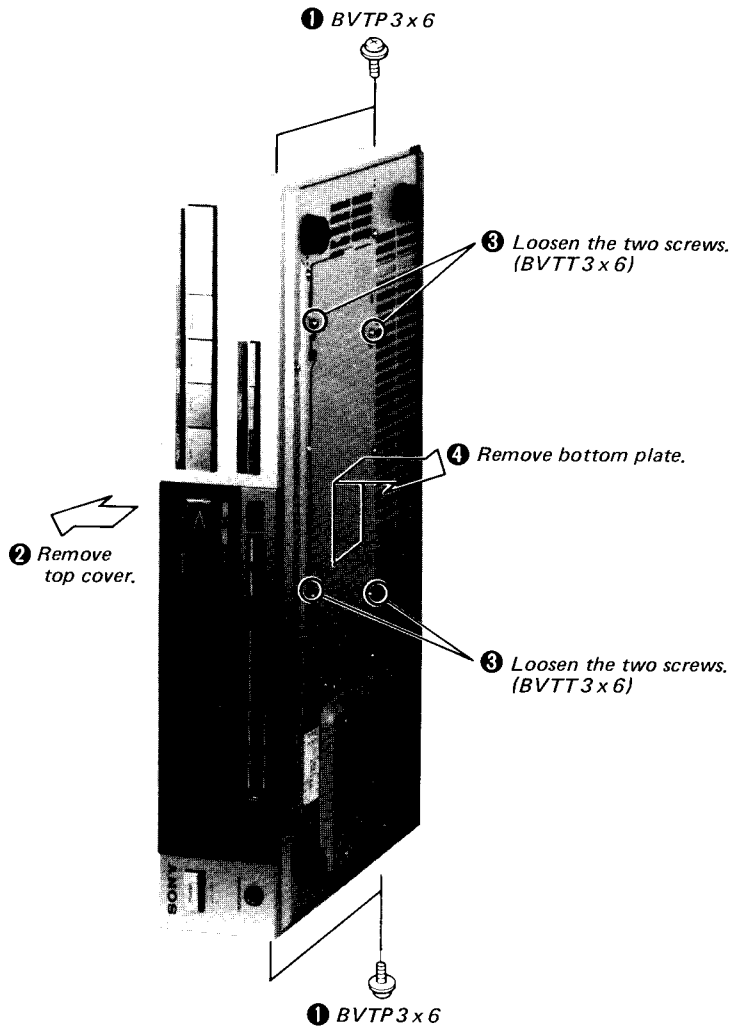

*The conductor side of the audio circuit board
can be checked in this condition.*

MICON BOARD

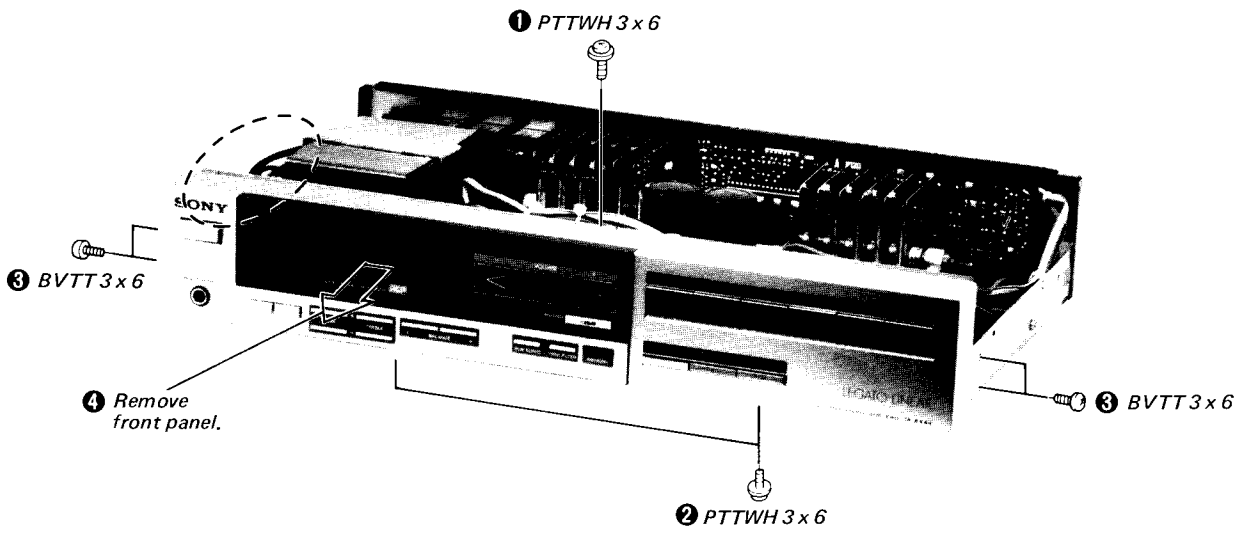

front panel

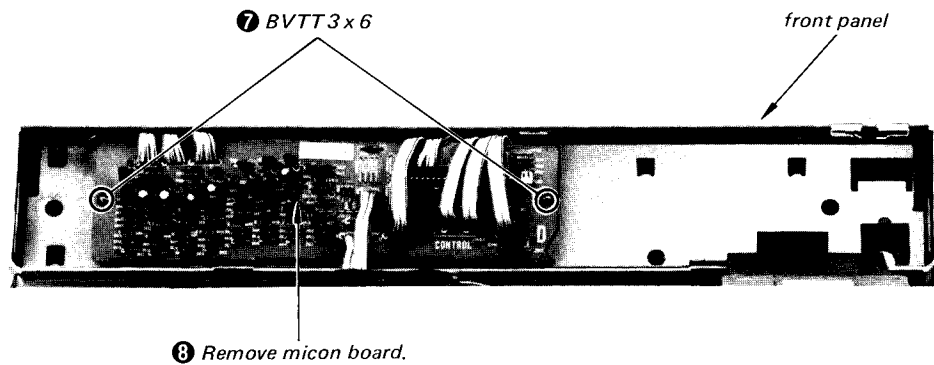
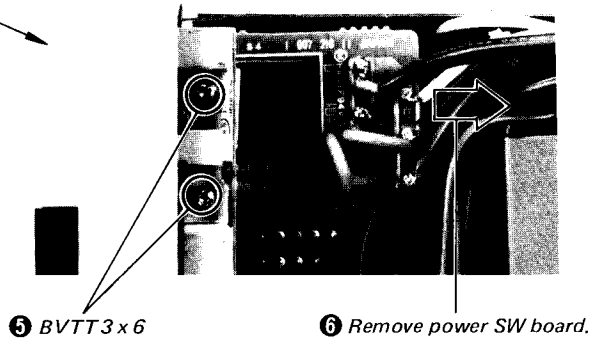

FUNCTION BOARD/DISPLAY BOARD

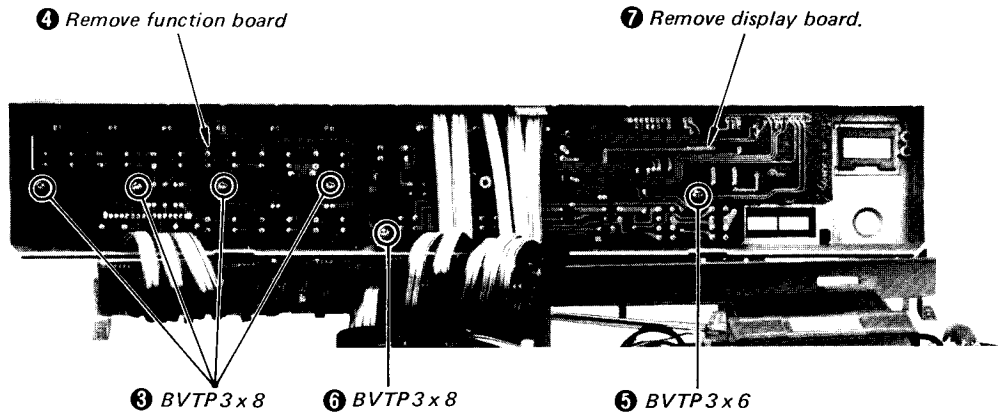
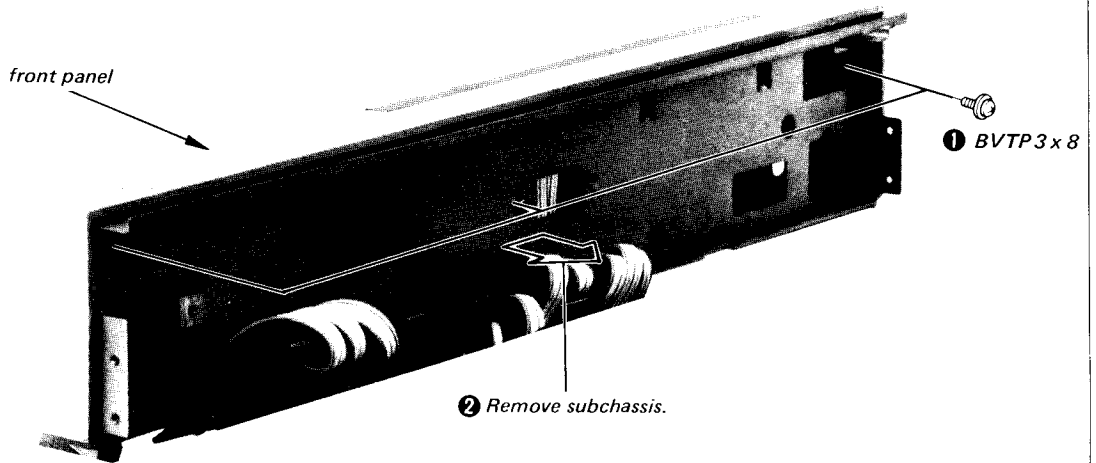

**SECTION 3
DIAGRAMS**

3-1. SCHEMATIC AND MOUNTING DIAGRAMS • See pages 17, 24 for the notes.

Power Supply Section for US, Canadian, E models. (See pages 15 – 24 for other sections.)

– US, Canadian Model –

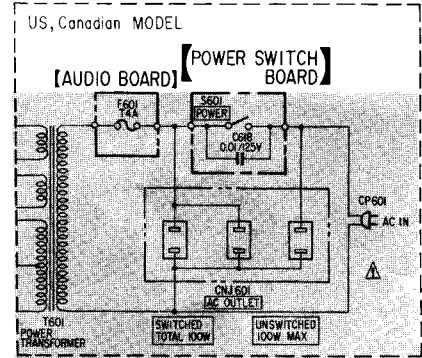
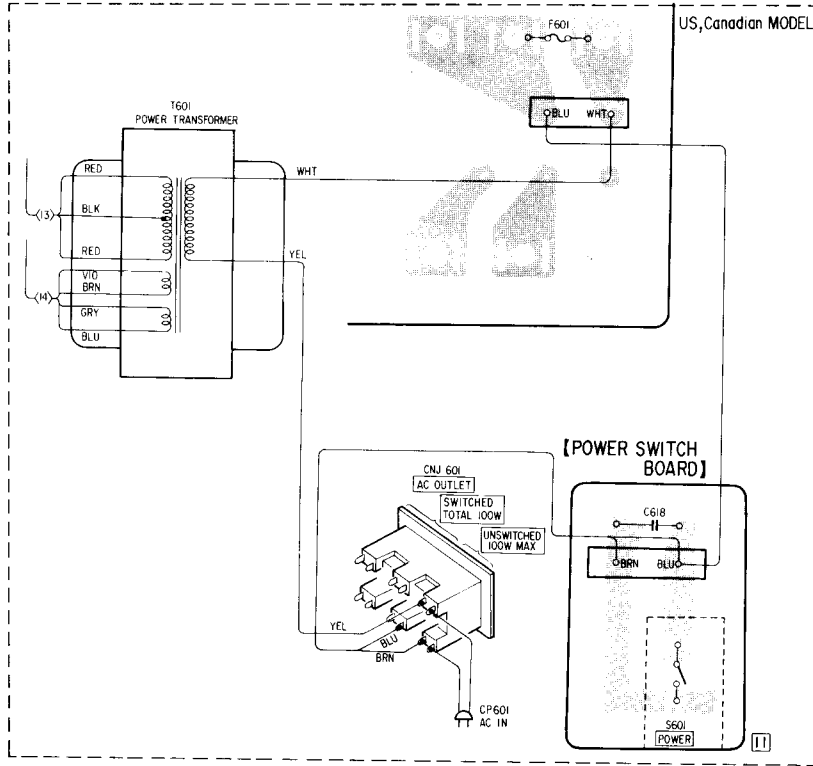

– E model –

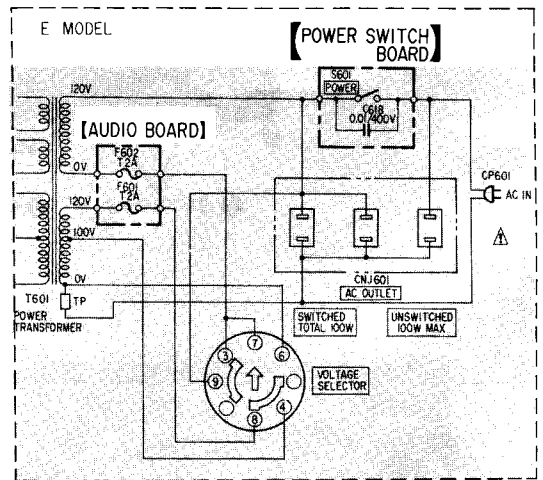
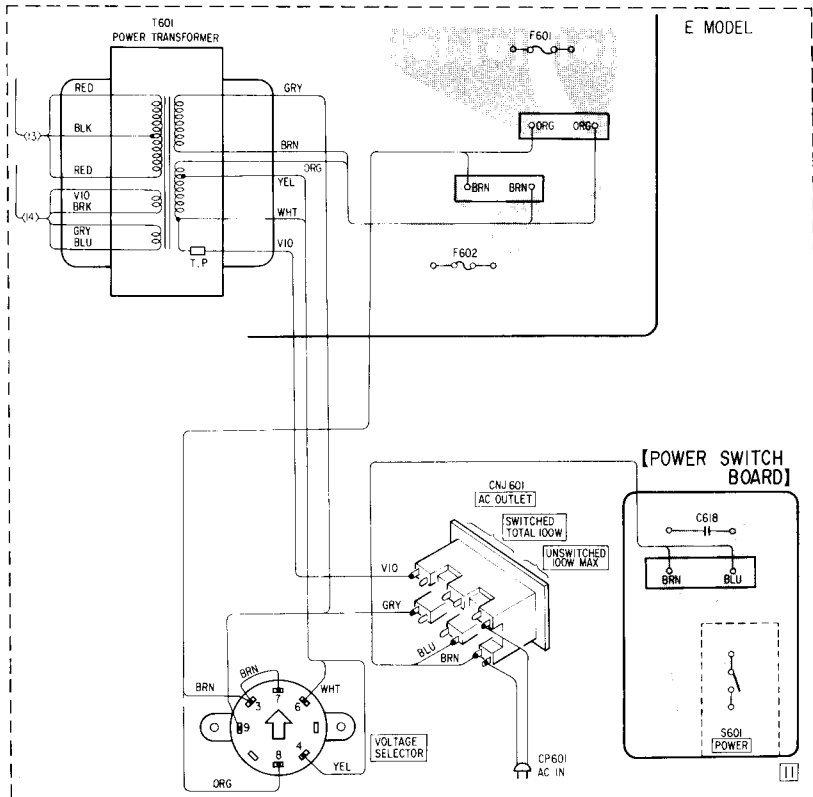

Note: The components identified by shading and mark  are critical for safety. Replace only with part number specified.

Note: Les composants identifiés par une trame et une marque  sont critiques pour la sécurité. Ne les remplacer que par une pièce portant le numéro spécifié.

A

B

C

D

3-2. SCHEMATIC DIAGRAM - Control Section -

1

2

3

4

5

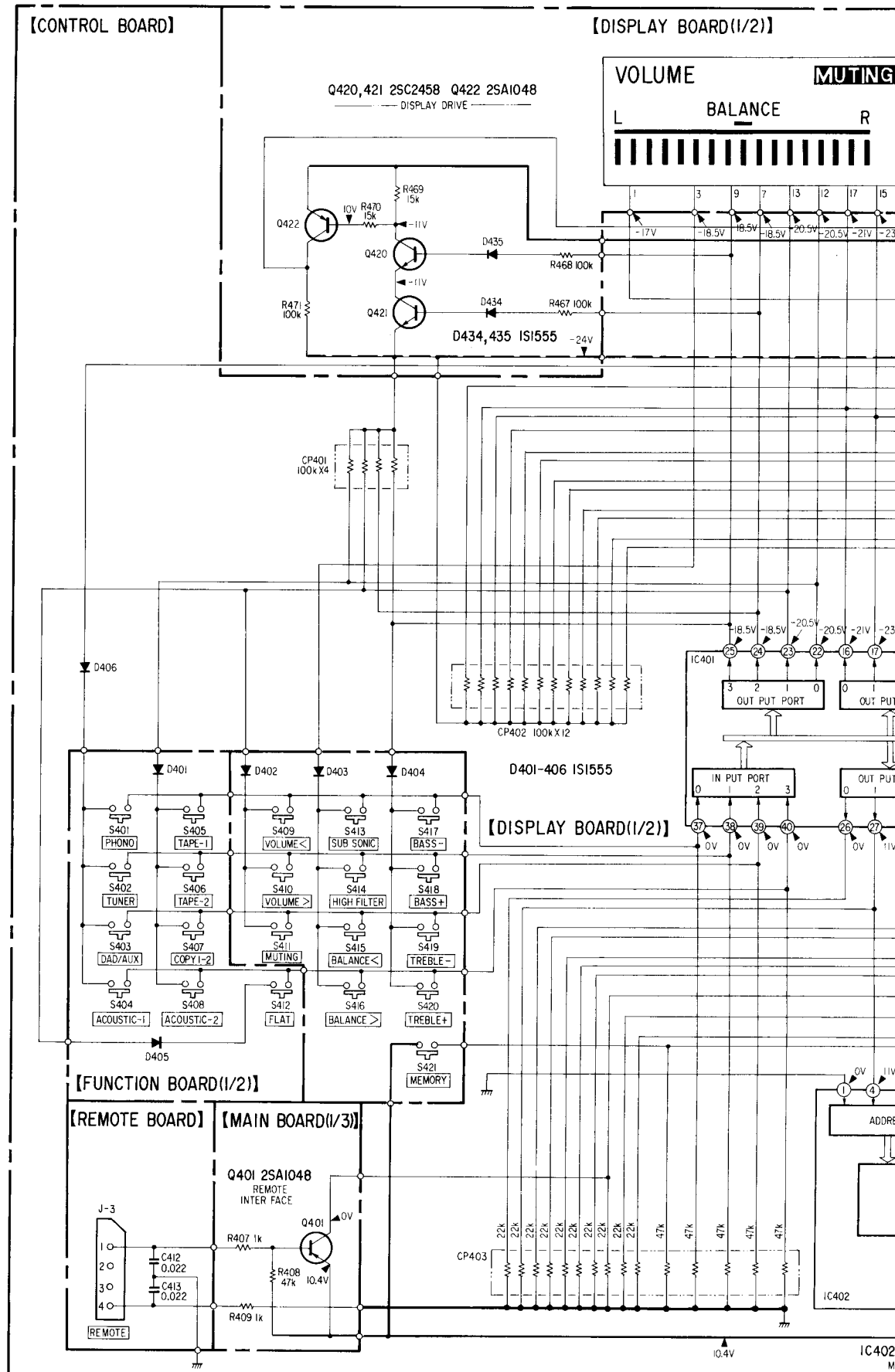

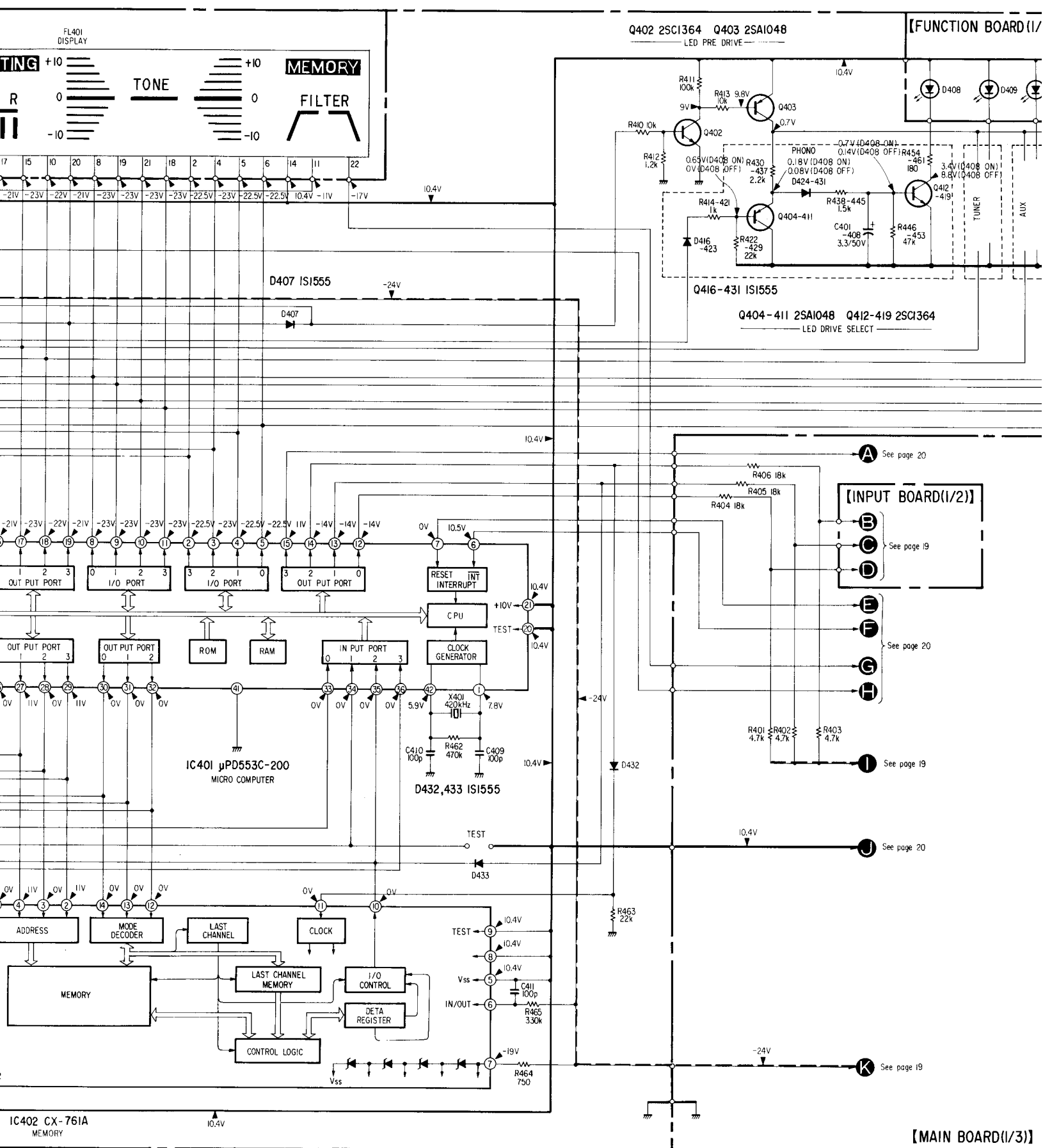

[FUNCTION BOARD (I/1)]

[INPUT BOARD (I/2)]

[MAIN BOARD (I/3)]

H I J K L

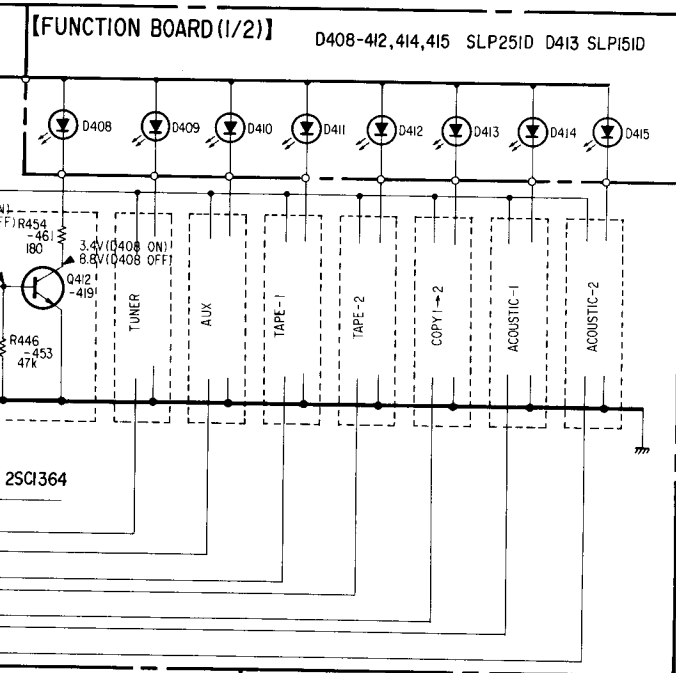

Notes:

- Components for right channel have same values as for left channel.
- All capacitors are in μF unless otherwise noted. pF : $\mu\mu\text{F}$ 50WV or less are not indicated except for electrolytics and tantalums.
- All resistors are in ohms, $\frac{1}{4}\text{W}$ unless otherwise noted. $\text{k}\Omega$: 1000 Ω , $\text{M}\Omega$: 1000 $\text{k}\Omega$
- : nonflammable resistor.
- : panel designation.
- : B+ bus.
- : B- bus.
- Voltages are dc with respect to ground unless otherwise noted.
- Readings are taken under no-signal conditions with a VOM (50 $\text{k}\Omega/\text{V}$).
- Voltage variations may be noted due to normal production tolerances.
- : W. GERMANY MODEL
- : signal path
- Switches

Ref. No.	Switch	Position
S301	SPEAKERS A	ON
S302	SPEAKERS B	OFF
S401	PHONO	OFF
S402	TUNER	OFF
S403	DAD/AUX	OFF
S404	ACOUSTIC-1	OFF
S405	TAPE-1	OFF
S406	TAPE-2	OFF
S407	COPY 1-2	OFF
S408	ACOUSTIC-2	OFF
S409	VOLUME <	OFF
S410	VOLUME >	OFF
S411	MUTING	OFF
S412	FLAT	OFF
S413	SUBSONIC	OFF
S414	HIGH FILTER	OFF
S415	BALANCE <	OFF
S416	BALANCE >	OFF
S417	BASS -	OFF
S418	BASS +	OFF
S419	TREBLE -	OFF
S420	TREBLE +	OFF
S421	MEMORY	OFF
S601	POWER	OFF

Note: Voltages are measured with a VOM (50 $\text{k}\Omega/\text{V}$).

Note: The components identified by shading and mark are critical for safety. Replace only with part number specified.

Note: Les composants identifiés par une trame et une marque sont critiques pour la sécurité. Ne les remplacer que par une pièce portant le numéro spécifié.

page 20

BOARD(1/2)

page 19

page 20

page 19

page 20

page 19

MAIN BOARD(1/3)

3-3. SCHEMATIC DIAGRAM - Audio Section - • See page 17 for the notes.

1
2
3
4
5

A B C D

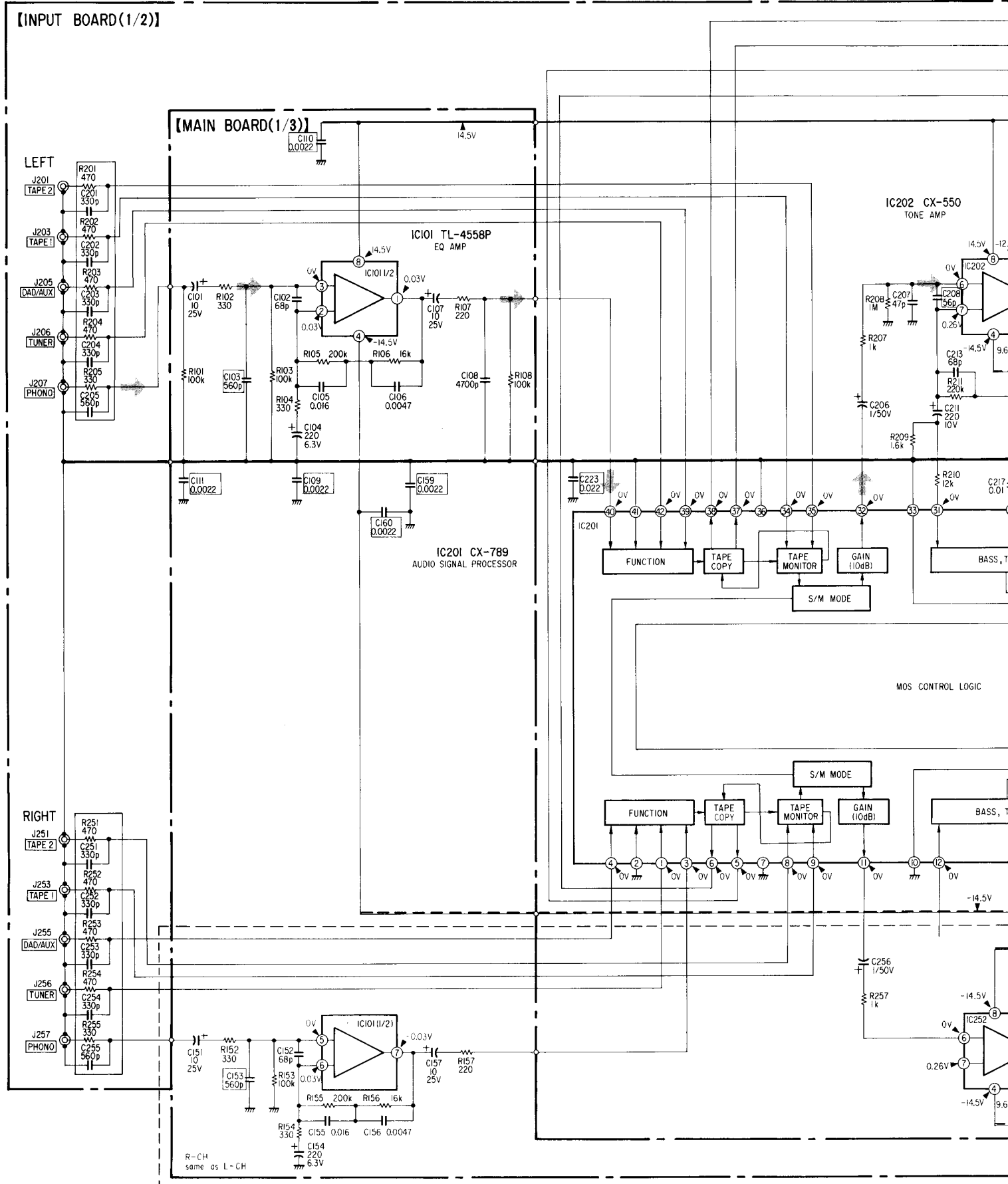

D E F G H

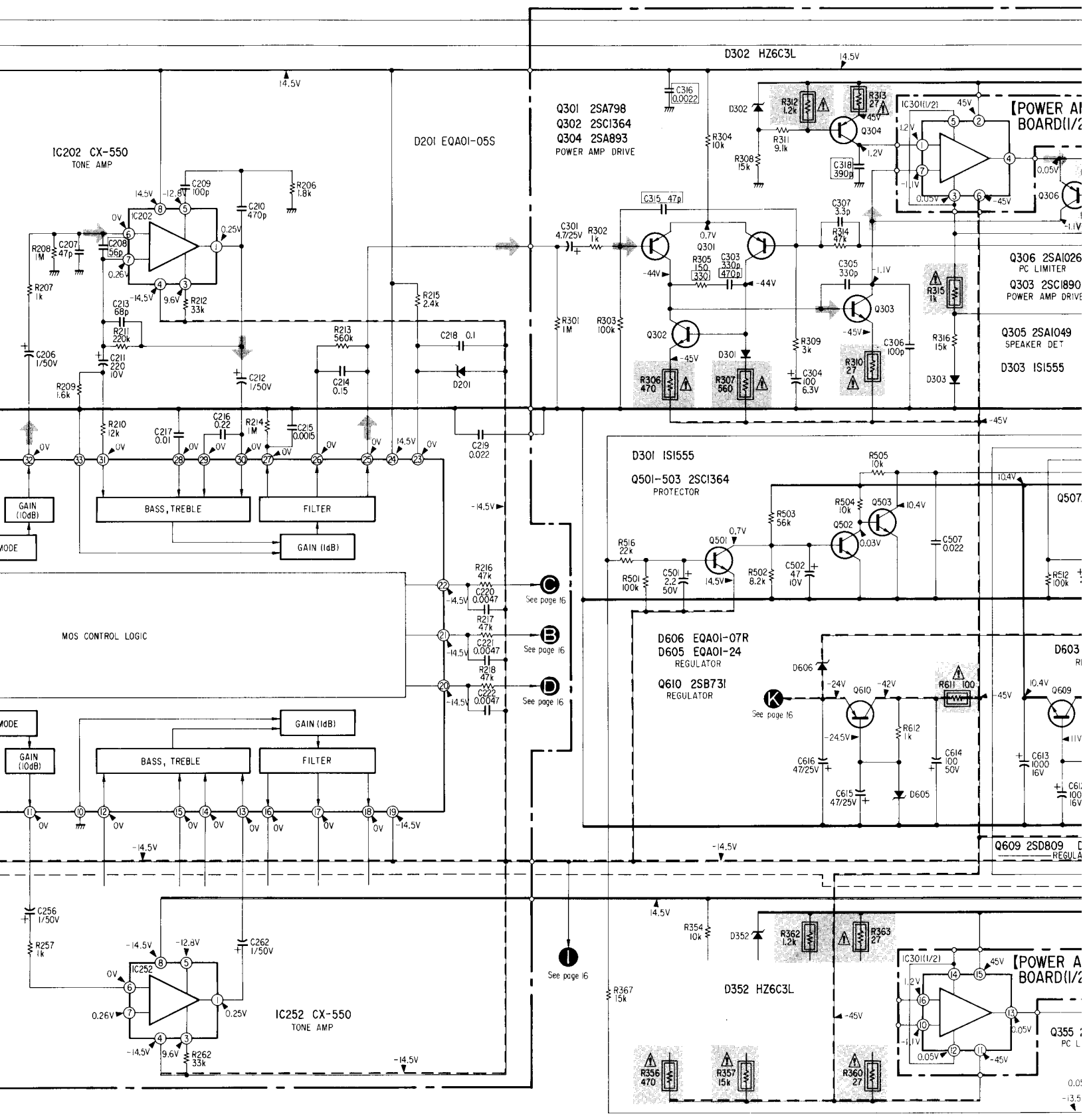

3-4. MOUNTING DIAGRAM

• See page 25 for semiconductor lead layouts.

Q		IC201	IC202		IC301
IC		IC201	IC252		
D	201				

1

2

3

4

5

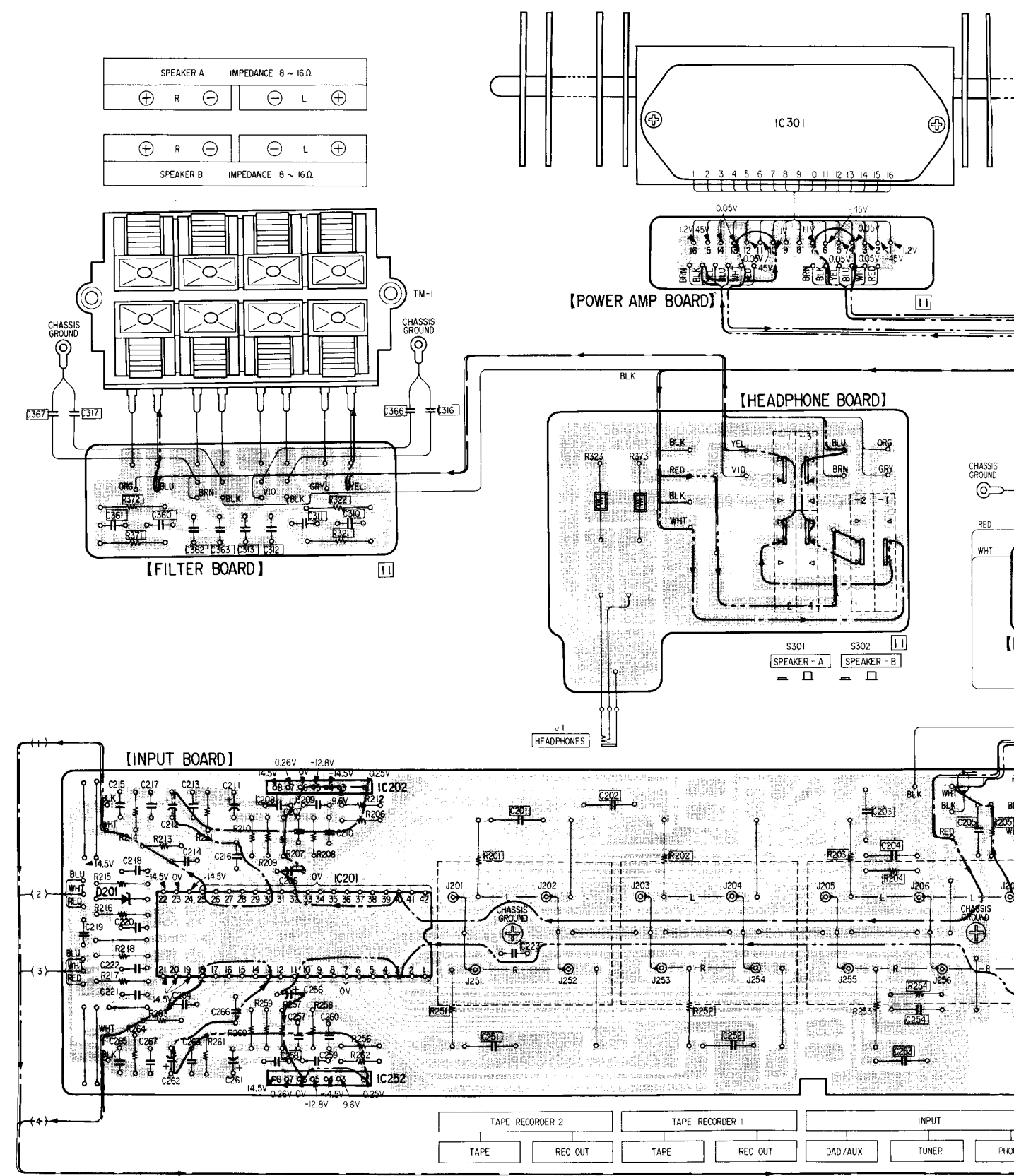

I	J	K	L
510 509 506	508 507 504	503 502 501	303 302
	306 301	305 304	
			IC402 IC401
			402 403 411
301		303 302	
			407
501			435 433 431 423
			402

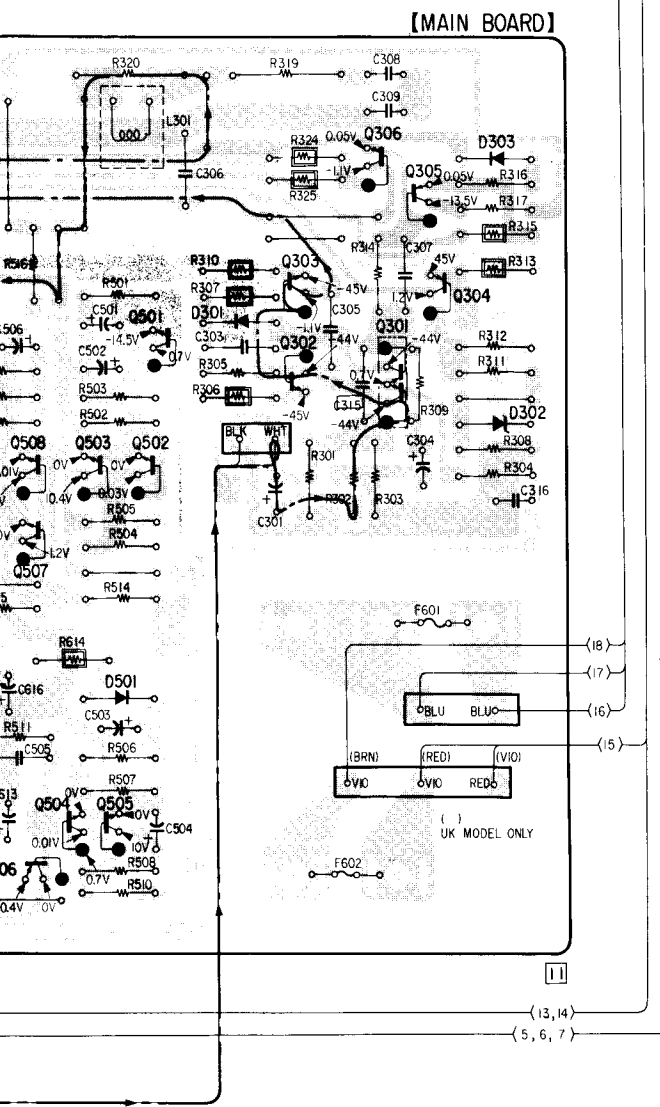
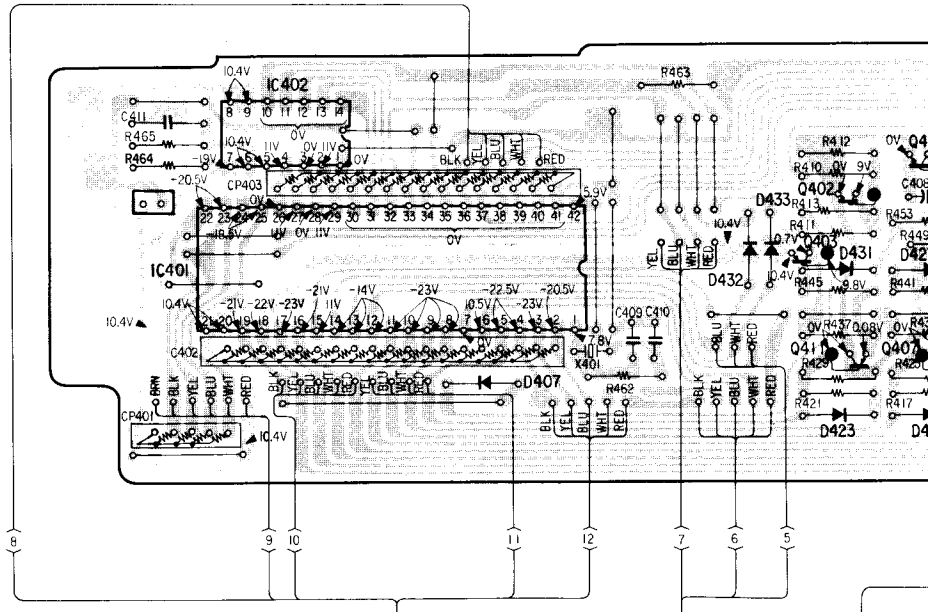
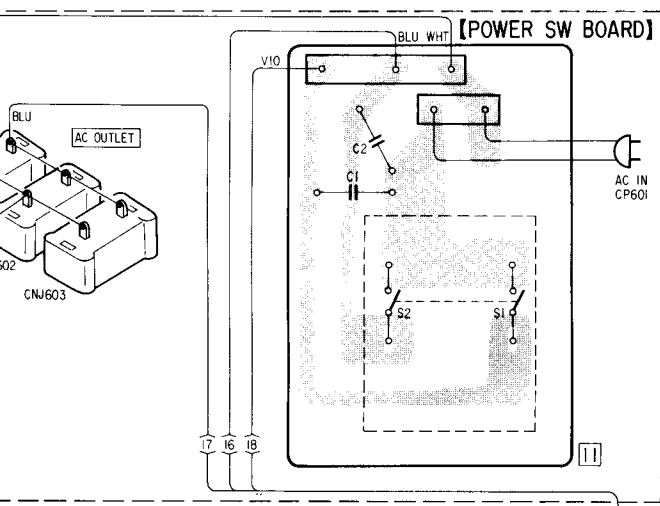

405	406	420	421	405	415	414	408	409	410	411	412	413	Q	IC
425	426												D	
417	418													
434														

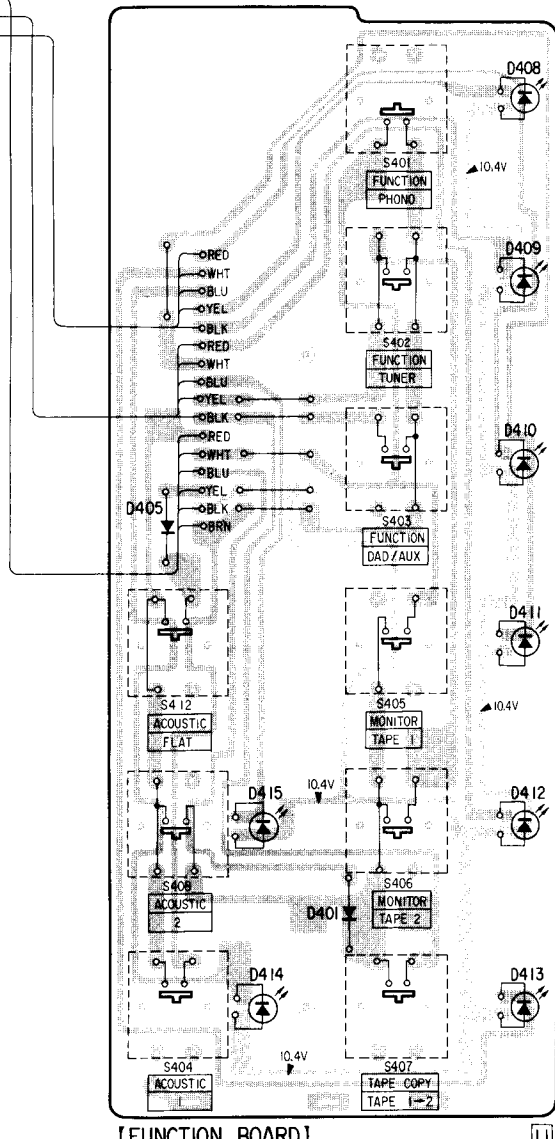
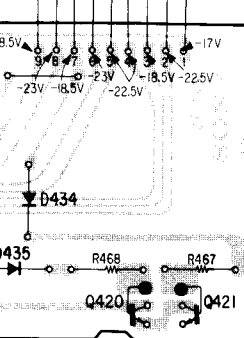
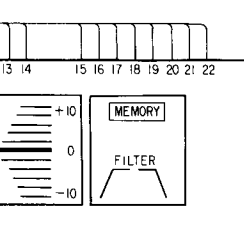
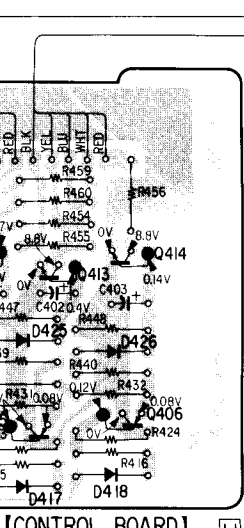

Note:

• Color code of sleeving over the end of the jacket.

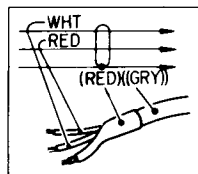

- ○ — : parts extracted from the component side.
- ● — : parts extracted from the conductor side.
- ■ : part mounted on the conductor side.
- ▨ : B + pattern

- ———> : signal path
- - - - -> : L-CH signal path
- - · - · -> : R-CH signal path
- □ : W. GERMANY MODEL

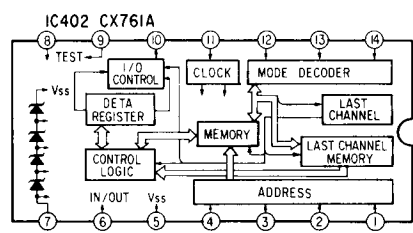
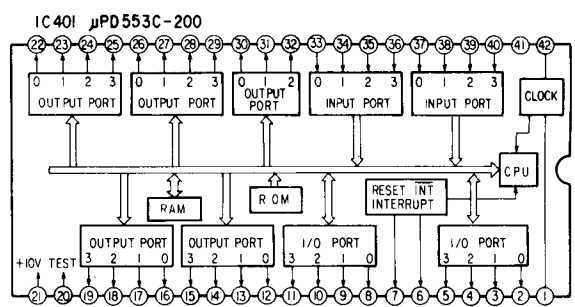
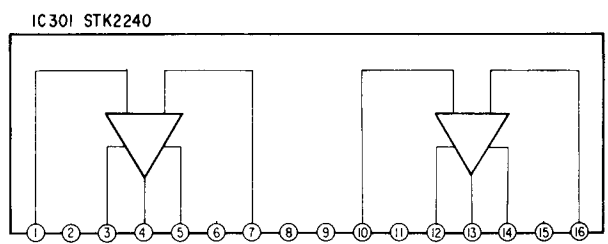
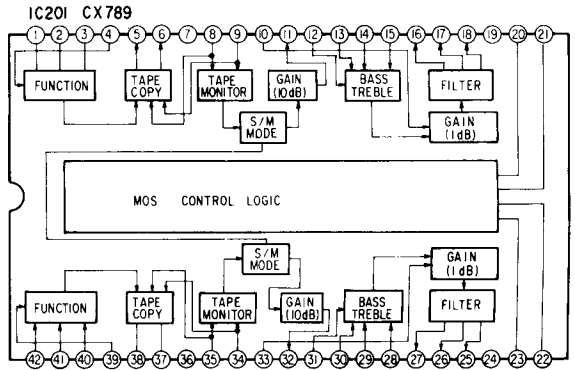
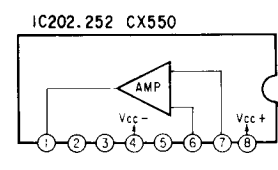
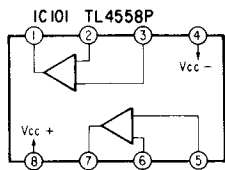

Semiconductor Lead Layouts

10E2
EQA01-05R
HZ6C3L
HZ7A1L
HZ24-1L
IS1555

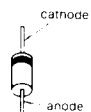

2SA798



EQB01-1L

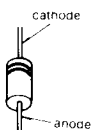

2SA1027R



S4VB40

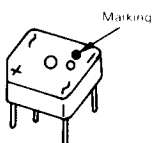

2SA1048
2SA1049
2SC2458

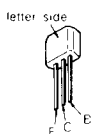

CX-550

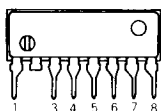

2SB731
2SD809



CX-761A

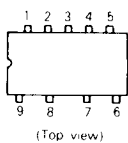

2SC1364
2SC1890-F

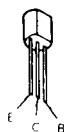

CX-789

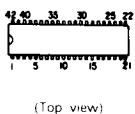

2SK246



TL-4558PK

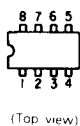

STK2240

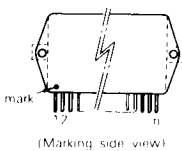

SECTION 4
EXPLODED VIEWS AND PARTS LIST

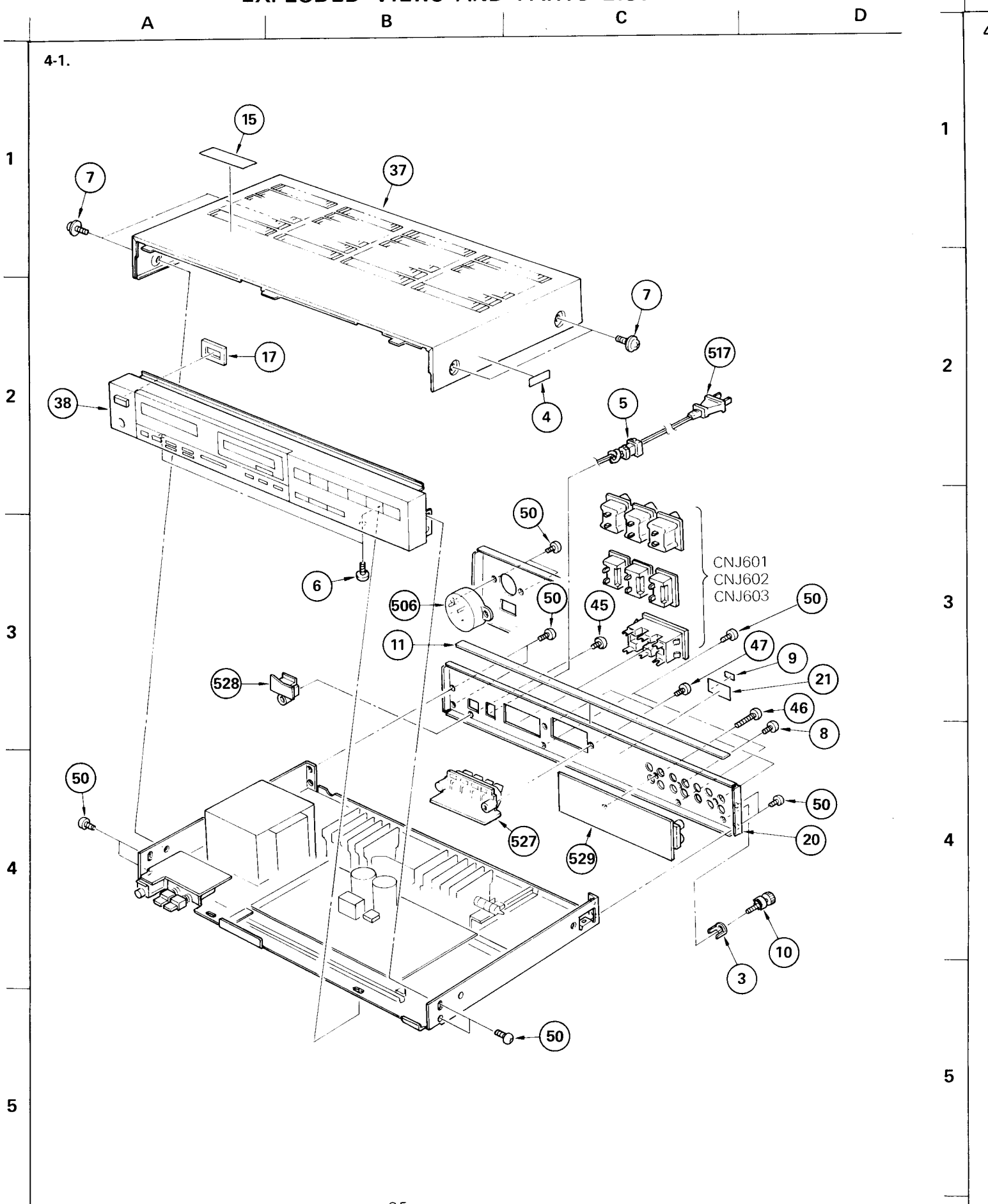

A

B

C

D

4-3.

1

2

3

4

5

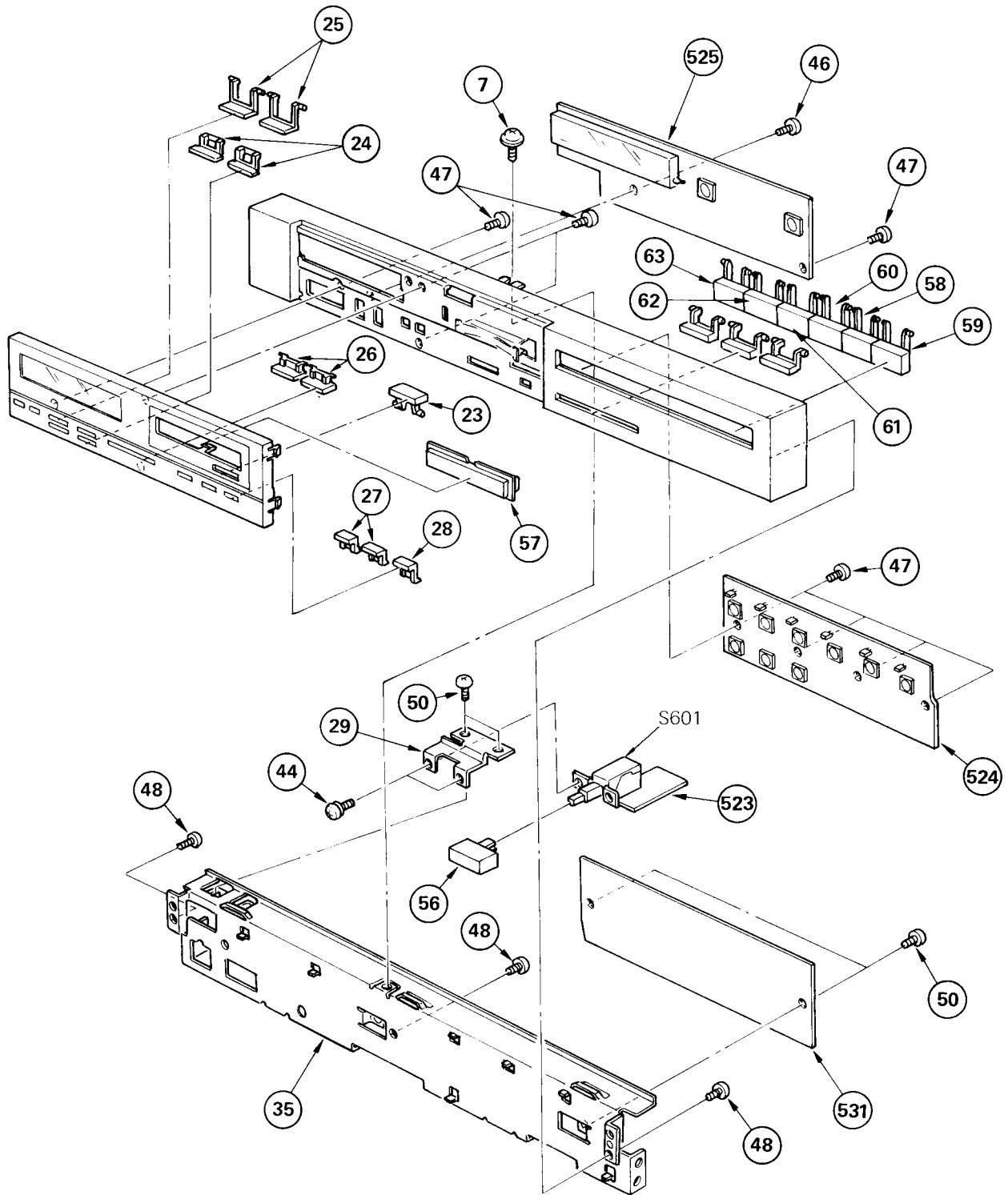

GENERAL SECTION

No.	Part No.	Description
1	2-363-012-00	KNOB (6X14), CORNER
2	3-701-948-17	(AEP,GAEP,E)...LABEL, FUSE
3	3-701-993-00	SPACER, TERMINAL
4	♣;3-703-044-25	LABEL, CAUTION
5	♣;3-703-244-00	BUSHING, CORD
6	3-703-249-01	SCREW, S TIGHT, +PTTWH 3X6
7	3-703-354-11	SCREW (OS), CASE, CLAW
8	3-703-473-00	SCREW, TERMINAL
9	3-703-540-02	(GAEP).....INSTRUCTION, FTZ
10	3-706-165-00	SCREW
11	4-015-736-00	CUSHION, CHASSIS
12	
13	4-848-642-00	CUSHION, VIBRATION
14	♣;4-861-002-11	HEAT SINK
15	4-861-045-00	(AEP,GAEP,UK).....LABEL, CAUTION
15	4-861-045-01	(US,Canadian,E)...LABEL, CAUTION
16	4-864-307-00	RING
17	4-871-324-00	ESCUTCHEON, POWER KNOB
18	♣;4-875-157-00	HOLDER, PIPE
19	♣;4-875-170-00	BLOCK, POWER
20	♣;4-882-002-00	(US,Canadian)...PLATE, JACK
20	♣;4-882-003-00	(AEP,GAEP).....PLATE, JACK
20	♣;4-882-004-00	(UK).....PLATE, JACK
20	♣;4-882-005-00	(E).....PLATE, JACK
21	4-882-007-01	(US).....LABEL, MODEL NUMBER
21	4-882-008-01	(Canadian)...LABEL, MODEL NUMBER
21	4-882-009-01	(AEP,GAEP)...LABEL, MODEL NUMBER
21	4-882-010-01	(UK).....LABEL, MODEL NUMBER
21	4-882-011-01	(E1).....LABEL, MODEL NUMBER
21	4-882-012-01	(E2).....LABEL, MODEL NUMBER
21	4-882-012-11	(E2).....LABEL, MODEL NUMBER
22	♣;4-882-013-00	RETAINER, PIPE
23	4-882-014-00	KNOB, MUTING
24	4-882-018-00	KNOB (A), CONTROL
25	4-882-019-00	KNOB (B), CONTROL
26	4-882-020-00	KNOB (C), CONTROL
27	4-882-021-01	KNOB (D), CONTROL
28	4-882-021-11	KNOB (D), CONTROL
29	♣;4-882-023-00	BRACKET, SWITCH, POWER.
30	♣;4-882-024-00	BRACKET, PC BOARD
31	♣;4-882-025-00	FRAME (A), CENTER
32	♣;4-882-026-00	FRAME (B), CENTER
33	♣;4-882-027-00	PIPE, HEAT
34	♣;4-882-028-00	PLATE, BOTTOM
35	♣;4-882-029-00	CHASSIS, SUB
36	♣;4-882-031-00	CHASSIS, MAIN

NOTE:

- Items with no part number and no description are not stocked because they are seldom required for routine service.
- Items marked "♣" are not stocked since they are seldom required for routine service. Some delay should be anticipated when ordering these items.
- Due to standardization, parts with part numbers (Δ-ΔΔΔ-ΔΔΔ-XX or Δ-ΔΔΔΔ-ΔΔΔ-X) may be different from those used in the set.

SEMICONDUCTORS

In each case, U : μ, for example:
 UA...: μA...; UPA...: μPA...; UPC...: μPC,
 UPD...: μPD...

CAPACITORS:

- All capacitors are in μF. Common capacitors are omitted. Refer to the following lists for their part numbers.
 MF:μF, PF:μμF.

RESISTORS

- All resistors are in ohms. Common 1/4W, 1/8W and 1/16W carbon resistors are omitted. Refer to the following lists for their part numbers.
- F : nonflammable

COILS

MMH : mH, UH : μH

GENERAL SECTION

No.	Part No.	Description
37	4-882-032-00	CASE
38	4-882-033-00	PANEL
39	4-882-034-00	SPACER, TERMINAL, 2 GANG
40	4-882-039-00	PLATE (A), GROUND
41	4-882-040-00	PLATE (B), GROUND
42	4-882-041-00	RETAINER, LED
43	7-623-508-01	(GAEP).....LUG, 3
44	7-682-647-01	SCREW +PS 3X6
45	7-685-133-11	SCREW +P 2.6X6 TYPE1
46	7-685-645-19	SCREW +BVTP 3X6 TYPE2 N-S
47	7-685-646-11	SCREW +BVTP 3X8 TYPE2 N-S
48	7-685-646-29	SCREW +BVTP 3X8 TYPE2 SLIT
49	7-685-650-29	SCREW +BVTP 3X16 TYPE2 SLIT
50	7-685-871-01	SCREW +BVTT 3X6 (S)
51	
52	7-685-872-01	SCREW +BVTT 3X8 (S)
53	7-685-881-01	SCREW +BVTT 4X8 (S)
54	
55	X-3701-069-0	FOOT ASSY, M.F
56	X-4875-108-0	KNOB ASSY, POWER
57	X-4882-001-0	KNOB ASSY, CONTROL
58	X-4882-002-0	KNOB (PHONO) ASSY, PUSH
59	X-4882-003-0	KNOB (TUNER) ASSY, PUSH
60	X-4882-005-0	KNOB (DAD/AUX) ASSY, PUSH
61	X-4882-006-0	KNOB (TAPE 1) ASSY, PUSH
62	X-4882-007-0	KNOB (TAPE 2) ASSY, PUSH
63	X-4882-008-0	KNOB (TAPE 1-2) ASSY, PUSH

ACCESSORY & PACKING MATERIAL

No.	Part No.	Description
101	3-701-630-00	BAG, POLYETHYLENE
102	3-703-390-01	(US)...INSTRUCTION
103	3-783-959-11	(UK,E,AEP,GAEP)...MANUAL, INSTRUCTION
103	3-783-959-21	(US,Canadian).....MANUAL, INSTRUCTION
103	3-783-959-31	(Canadian).....MANUAL, INSTRUCTION
104	4-875-448-00	CUSHION, UPPER
105	4-875-449-00	CUSHION, LOWER
106	4-876-352-00	SHEET, PROTECTION
107	4-882-042-00	INDIVIDUAL CARTON
108	9-911-863-XX	(AEP,GAEP,UK)...SHEET, INSTRUCTION

The components identified by shading and mark **♣** are critical for safety. Replace only with part number specified.

Les composants identifiés par une trame et une marque **♣** sont critiques pour la sécurité. Ne les remplacer que par une pièce portant le numéro spécifié.

ELECTRICAL PARTS

Ref.No.	Part No.	Description
501	♣;1-508-809-00	(US,Canadian,AEP,UK,E)..BASE POST(14MM)2P
502	♣;1-508-810-00	(US,Canadian,AEP,UK,E)..14MM BASE POST
503	1-517-072-00	(US,Canadian)...HOLDER, LAMP
504	♣.1-526-565-12	(E).....AC PLUG ADAPTOR
505	♣.1-526-574-00	(US,Canadian,E)...OUTLET, AC (3 GANG)
505	♣.1-526-636-00	(UK).....OUTLET, AC
505	♣.1-526-694-00	(AEP,GAEP).....OUTLET, AC
506	♣.1-526-576-12	(E).....SELECTOR, POWER VOLTAGE
507	♣.1-532-131-11	(UK,E,AEP,GAEP)...HOLDER, FUSE
508	♣.1-532-203-11	(UK,E,AEP,GAEP)...FUSE, TIME-LAG
509	♣.1-532-349-XX	(US,Canadian).....FUSE
510	♣;1-535-115-00	TERMINAL
511	♣;1-535-116-00	TERMINAL
512	♣;1-535-122-00	TERMINAL, 9P
513	♣;1-535-135-00	(AEP,GAEP,UK,E)..... BASE POST 14MM (10MM PITCH)
513	♣;1-535-139-00	(US,Canadian,AEP,GAEP,E).... BASE POST 19MM (10MM PITCH) 2P
513	♣;1-535-140-00	(AEP,GAEP,UK)..... BASE POST 19MM (10MM PITCH) 3P
514	♣;1-535-149-11	WIRE (30.0MM)
515	1-535-416-00	(AEP,GAEP)...TERMINAL
516	1-536-706-00	TERMINAL BOARD (SP)
517	♣.1-551-472-00	(E).....CORD, POWER
517	♣.1-551-551-00	(Canadian)...CORD, POWER
517	♣.1-551-628-00	(US).....CORD, POWER
517	♣.1-551-817-00	(AEP,GAEP)...CORD, POWER
517	♣.1-551-967-00	(UK).....CORD, POWER
518	♣;1-560-039-00	PIN, CONNECTOR
519	♣;1-560-060-00	PIN, CONNECTOR 2P
520	♣;1-560-602-00	PIN, CONNECTOR 3P
521	♣;1-560-603-00	PIN, CONNECTOR 4P
522	♣;1-560-604-00	PIN, CONNECTOR 5P
523	♣;1-607-216-00	(AEP,GAEP).....PC BOARD, POWER SWITCH
523	♣;1-607-217-00	(UK).....PC BOARD, POWER SWITCH
523	♣;1-607-990-00	(US,Canadian,E)...PC BOARD, AC SWITCH
524	♣;1-607-986-00	PC BOARD, FUNCTION
525	♣;1-607-987-00	PC BOARD, DISPLAY
526	♣;1-607-988-00	PC BOARD, HEADPHONE
527	♣;1-607-989-00	PC BOARD, OUTPUT
528	♣;1-607-991-00	PC BOARD, REMOCON TERMINAL
529	A-4382-119-A	MOUNTED PCB, INPUT
530	♣;A-4382-317-A	(UK).....MOUNTED PCB, AUDIO
530	♣;A-4388-321-A	(AEP,GAEP).....MOUNTED PCB, AUDIO
530	♣;A-4388-323-A	(US,Canadian)...MOUNTED PCB, AUDIO
530	♣;A-4388-324-A	(E).....MOUNTED PCB, AUDIO
531	♣;A-4409-657-A	MOUNTED PCB, MICON

ELECTRICAL PARTS

Ref.No.	Part No.	Description			
C105	1-108-584-00	MYLAR	0.016MF	5%	50V
C155	1-108-584-00	MYLAR	0.016MF	5%	50V
C214	1-130-634-00	FILM	0.15MF	5%	50V
C216	1-130-636-00	FILM	0.22MF	5%	50V
C218	1-130-632-00	FILM	0.1MF	5%	50V
C264	1-130-634-00	FILM	0.15MF	5%	50V
C266	1-130-636-00	FILM	0.22MF	5%	50V
C303	1-161-317-00	CERAMIC	330PF	10%	50V
C307	1-161-253-00	CERAMIC	3.3PF	10%	50V
C307	1-161-253-00	CERAMIC	3.3PF	10%	50V
C353	1-161-317-00	CERAMIC	330PF	10%	50V
C357	1-161-253-00	CERAMIC	3.3PF	10%	50V
C601	♣.1-102-394-00	CERAMIC			250V
C602	♣.1-125-292-00	ELECT(BLOCK) 8200MF		20%	50V
C606	♣.1-125-292-00	ELECT(BLOCK) 8200MF		20%	50V
CP403	♣;1-607-985-00	PC BOARD, MICRO COMPUTER			
D201	8-719-936-05	DIODE EQA01-05R			
D301	8-719-815-55	DIODE 1S1555			
D302	8-719-910-69	DIODE HZ6C3L			
D303	8-719-815-55	DIODE 1S1555			
D304	8-719-815-55	DIODE 1S1555			
D351	8-719-815-55	DIODE 1S1555			
D352	8-719-910-69	DIODE HZ6C3L			
D353	8-719-815-55	DIODE 1S1555			
D401	8-719-815-55	DIODE 1S1555			
D402	8-719-815-55	DIODE 1S1555			
D403	8-719-815-55	DIODE 1S1555			
D404	8-719-815-55	DIODE 1S1555			
D405	8-719-815-55	DIODE 1S1555			
D406	8-719-815-55	DIODE 1S1555			
D407	8-719-815-55	DIODE 1S1555			
D416	8-719-815-55	DIODE 1S1555			
D417	8-719-815-55	DIODE 1S1555			
D418	8-719-815-55	DIODE 1S1555			
D419	8-719-815-55	DIODE 1S1555			
D420	8-719-815-55	DIODE 1S1555			
D421	8-719-815-55	DIODE 1S1555			
D422	8-719-815-55	DIODE 1S1555			
D423	8-719-815-55	DIODE 1S1555			
D424	8-719-815-55	DIODE 1S1555			
D425	8-719-815-55	DIODE 1S1555			
D426	8-719-815-55	DIODE 1S1555			
D427	8-719-815-55	DIODE 1S1555			
D428	8-719-815-55	DIODE 1S1555			
D429	8-719-815-55	DIODE 1S1555			
D430	8-719-815-55	DIODE 1S1555			

NOTE:

- Items with no part number and no description are not stocked because they are seldom required for routine service.
- Items marked "♣" are not stocked since they are seldom required for routine service. Some delay should be anticipated when ordering these items.
- Due to standardization, parts with part numbers (♣-♣♣♣-♣♣♣-XX or ♣-♣♣♣-♣♣♣-XX) may be different from those used in the set.

SEMICONDUCTORS

In each case, U : μ , for example:
 UA...: μ A..., UPA...: μ PA..., UPC...: μ PC,
 UPD...: μ PD...

CAPACITORS:

All capacitors are in μ F. Common capacitors are omitted. Refer to the following lists for their part numbers.
 MF: μ F, PF: μ μ F.

RESISTORS

All resistors are in ohms. Common 1/4W, 1/8W and 1/16W carbon resistors are omitted. Refer to the following lists for their part numbers.

F : nonflammable

COILS

MMH : mH, UH : μ H

The components identified by shading and mark ♣ are critical for safety. Replace only with part number specified.

Les composants identifiés par une trame et une marque ♣ sont critiques pour la sécurité. Ne les remplacer que par une pièce portant le numéro spécifié.

ELECTRICAL PARTS

Ref.No.	Part No.	Description
D431	8-719-815-55	DIODE 1S1555
D432	8-719-815-55	DIODE 1S1555
D433	8-719-815-55	DIODE 1S1555
D434	8-719-815-55	DIODE 1S1555
D435	8-719-815-55	DIODE 1S1555
D601	8-719-936-05	DIODE S4VB40
D602	8-719-910-69	DIODE HZ6C3L
D603	8-719-200-02	DIODE 10E2
D604	8-719-930-11	DIODE EQB01-1L
D605	8-719-910-41	DIODE HZ24-1L
D606	8-719-910-71	DIODE HZ7A1L
FL401	1-519-267-00	INDICATOR TUBE, FLUORESCENT
IC101	8-759-935-58	IC TL-4558PK
IC201	8-759-890-00	IC CX-789
IC202	8-759-305-50	IC CX-550
IC252	8-759-305-50	IC CX-550
IC301	8-759-922-00	IC STK2240
IC402	8-759-611-00	IC CX-761A
J-1	1-507-669-00	JACK
J201	1-507-740-00	JACK, PIN 4P
J202	1-507-740-00	JACK, PIN 4P
J203	1-507-740-00	JACK, PIN 4P
J204	1-507-740-00	JACK, PIN 4P
J205	1-507-741-21	JACK, PIN 6P
J206	1-507-741-21	JACK, PIN 6P
J207	1-507-741-21	JACK, PIN 6P
J251	1-507-740-00	JACK, PIN 4P
J252	1-507-740-00	JACK, PIN 4P
J253	1-507-740-00	JACK, PIN 4P
J254	1-507-740-00	JACK, PIN 4P
J255	1-507-741-21	JACK, PIN 6P
J256	1-507-741-21	JACK, PIN 6P
J257	1-507-741-21	JACK, PIN 6P
L301	♣;1-420-872-00	COIL, AIR CORE
L351	♣;1-420-872-00	COIL, AIR CORE
Q301	8-729-679-82	TRANSISTOR 2SA798
Q302	8-729-663-47	TRANSISTOR 2SC1364
Q303	8-729-389-09	TRANSISTOR 2SC1890-F
Q304	8-729-612-77	TRANSISTOR 2SA1027R
Q305	8-729-204-91	TRANSISTOR 2SA1049
Q306	8-729-612-77	TRANSISTOR 2SA1027R
Q351	8-729-679-82	TRANSISTOR 2SA798
Q352	8-729-663-47	TRANSISTOR 2SC1364
Q353	8-729-389-09	TRANSISTOR 2SC1890-F

ELECTRICAL PARTS

Ref.No.	Part No.	Description
Q354	8-729-612-77	TRANSISTOR 2SA1027R
Q355	8-729-204-91	TRANSISTOR 2SA1049
Q356	8-729-612-77	TRANSISTOR 2SA1027R
Q401	8-729-204-82	TRANSISTOR 2SA1048
Q402	8-729-663-47	TRANSISTOR 2SC1364
Q403	8-729-204-82	TRANSISTOR 2SA1048
Q404	8-729-204-82	TRANSISTOR 2SA1048
Q405	8-729-204-82	TRANSISTOR 2SA1048
Q406	8-729-204-82	TRANSISTOR 2SA1048
Q407	8-729-204-82	TRANSISTOR 2SA1048
Q408	8-729-204-82	TRANSISTOR 2SA1048
Q409	8-729-204-82	TRANSISTOR 2SA1048
Q410	8-729-204-82	TRANSISTOR 2SA1048
Q411	8-729-204-82	TRANSISTOR 2SA1048
Q412	8-729-663-47	TRANSISTOR 2SC1364
Q413	8-729-663-47	TRANSISTOR 2SC1364
Q414	8-729-663-47	TRANSISTOR 2SC1364
Q415	8-729-663-47	TRANSISTOR 2SC1364
Q416	8-729-663-47	TRANSISTOR 2SC1364
Q417	8-729-663-47	TRANSISTOR 2SC1364
Q418	8-729-663-47	TRANSISTOR 2SC1364
Q419	8-729-663-47	TRANSISTOR 2SC1364
Q420	8-729-245-83	TRANSISTOR 2SC2458
Q421	8-729-245-83	TRANSISTOR 2SC2458
Q422	8-729-204-82	TRANSISTOR 2SA1048
Q501	8-729-663-47	TRANSISTOR 2SC1364
Q502	8-729-663-47	TRANSISTOR 2SC1364
Q503	8-729-663-47	TRANSISTOR 2SC1364
Q504	8-729-663-47	TRANSISTOR 2SC1364
Q505	8-729-663-47	TRANSISTOR 2SC1364
Q506	8-729-204-82	TRANSISTOR 2SA1048
Q507	8-729-663-47	TRANSISTOR 2SC1364
Q508	8-729-663-47	TRANSISTOR 2SC1364
Q509	8-729-663-47	TRANSISTOR 2SC1364
Q510	8-729-663-47	TRANSISTOR 2SC1364
Q601	8-729-224-61	TRANSISTOR 2SK246
Q602	8-729-663-47	TRANSISTOR 2SC1364
Q603	8-729-180-91	TRANSISTOR 2SD809
Q604	8-729-663-47	TRANSISTOR 2SC1364
Q605	8-729-224-61	TRANSISTOR 2SK246
Q606	8-729-204-82	TRANSISTOR 2SA1048
Q607	8-729-173-13	TRANSISTOR 2SB731
Q608	8-729-204-82	TRANSISTOR 2SA1048
Q609	8-729-180-91	TRANSISTOR 2SD809
Q610	8-729-173-13	TRANSISTOR 2SB731

NOTE:

- Items with no part number and no description are not stocked because they are seldom required for routine service.
- Items marked "♣" are not stocked since they are seldom required for routine service. Some delay should be anticipated when ordering these items.
- Due to standardization, parts with part numbers (Δ - $\Delta\Delta\Delta$ - $\Delta\Delta\Delta$ -XX or Δ - $\Delta\Delta\Delta$ - $\Delta\Delta\Delta$ -X) may be different from those used in the set.

CAPACITORS:

- All capacitors are in μ F. Common capacitors are omitted. Refer to the following lists for their part numbers.
MF: μ F, PF: μ F.

RESISTORS

- All resistors are in ohms. Common 1/4W, 1/8W and 1/16W carbon resistors are omitted. Refer to the following lists for their part numbers.
- F: nonflammable

SEMICONDUCTORS

- In each case, U: μ , for example:
UA...: μ A..., UPA...: μ PA..., UPC...: μ PC...,
UPD...: μ PD...

COILS

- MMH: mH, UH: μ H

ELECTRICAL PARTS

Ref.No.	Part No.	Description					
R306	△.1-247-123-00	CARBON	470	5%	1/4W	F	
R307	△.1-247-125-00	CARBON	560	5%	1/4W	F	
R310	△.1-247-093-00	CARBON	27	5%	1/4W	F	
R312	△.1-247-133-00	CARBON	1.2K	5%	1/4W	F	
R313	△.1-247-093-00	CARBON	27	5%	1/4W	F	
R315	△.1-247-131-00	CARBON	1K	5%	1/4W	F	
R319	△.1-244-825-51	CARBON	10	5%	1/2W		
R320	1-244-817-51	CARBON	4.7	5%	1/2W		
R323	△.1-247-232-00	CARBON	470	5%	1/2W	F	
R324	△.1-247-131-00	CARBON	1K	5%	1/4W	F	
R325	△.1-247-143-00	CARBON	3.3K	5%	1/4W	F	
R356	△.1-247-123-00	CARBON	470	5%	1/4W	F	
R357	△.1-247-125-00	CARBON	560	5%	1/4W	F	
R360	△.1-247-093-00	CARBON	27	5%	1/4W	F	
R362	△.1-247-133-00	CARBON	1.2K	5%	1/4W	F	
R363	△.1-247-093-00	CARBON	27	5%	1/4W	F	
R365	△.1-247-131-00	CARBON	1K	5%	1/4W	F	
R369	△.1-244-825-51	CARBON	10	5%	1/2W		
R370	1-244-817-00	CARBON	4.7	5%	1/2W		
R373	△.1-247-232-00	CARBON	470	5%	1/2W	F	
R374	△.1-247-131-00	CARBON	1K	5%	1/4W	F	
R375	△.1-247-143-00	CARBON	3.3K	5%	1/4W	F	
R513	△.1-244-873-51	CARBON	1K	5%	1/2W		
R601	△.1-206-654-00	METAL	390	5%	2W	F	
R605	△.1-206-654-00	METAL	390	5%	2W	F	
R609	△.1-247-079-00	CARBON	4.7	5%	1/4W	F	
R611	△.1-247-107-00	CARBON	100	5%	1/4W	F	
R614	△.1-247-079-00	CARBON	4.7	5%	1/4W	F	
RY301	1-515-348-00	RELAY					
RY351	1-515-348-00	RELAY					

NOTE:

- Items with no part number and no description are not stocked because they are seldom required for routine service.
- Items marked "●" are not stocked since they are seldom required for routine service. Some delay should be anticipated when ordering these items.
- Due to standardization, parts with part numbers (△-△△△-△△△-XX or △-△△△-△△△-X) may be different from those used in the set.

SEMICONDUCTORS

In each case, U : μ , for example:
 UA...: μ A..., UPA...: μ PA..., UPC...: μ PC,
 UPD...: μ PD...

CAPACITORS:

All capacitors are in μ F. Common capacitors are omitted. Refer to the following lists for their part numbers.
 MF: μ F, PF: μ F.

RESISTORS

All resistors are in ohms. Common 1/4W, 1/8W and 1/16W carbon resistors are omitted. Refer to the following lists for their part numbers.

F : nonflammable

COILS

MMH : mH, UH : μ H

ELECTRICAL PARTS

Ref.No.	Part No.	Description	
S301	1-554-125-00	SWITCH, PUSH (2 KEY)	
S302	1-554-125-00	SWITCH, PUSH (2 KEY)	
S401	1-552-539-00	SWITCH, KEY BOARD	
S402	1-552-539-00	SWITCH, KEY BOARD	
S403	1-552-539-00	SWITCH, KEY BOARD	
S404	1-552-539-00	SWITCH, KEY BOARD	
S405	1-552-539-00	SWITCH, KEY BOARD	
S406	1-552-539-00	SWITCH, KEY BOARD	
S407	1-552-539-00	SWITCH, KEY BOARD	
S408	1-552-539-00	SWITCH, KEY BOARD	
S409	1-552-539-00	SWITCH, KEY BOARD	
S410	1-552-539-00	SWITCH, KEY BOARD	
S411	1-553-856-00	SWITCH, KEY BOARD	
S412	1-552-539-00	SWITCH, KEY BOARD	
S413	1-553-856-00	SWITCH, KEY BOARD	
S414	1-553-856-00	SWITCH, KEY BOARD	
S415	1-553-856-00	SWITCH, KEY BOARD	
S416	1-553-856-00	SWITCH, KEY BOARD	
S417	1-553-856-00	SWITCH, KEY BOARD	
S418	1-553-856-00	SWITCH, KEY BOARD	
S419	1-553-856-00	SWITCH, KEY BOARD	
S420	1-553-856-00	SWITCH, KEY BOARD	
S421	1-553-856-00	SWITCH, KEY BOARD	
S601	△.1-553-318-00	(E).....SWITCH, PUSH (AC POWER)	
S601	△.1-553-319-00	(US,Canadian)...SWITCH, PUSH (AC POWER)	
S601	△.1-553-447-00	(AEP,GAEP,UK)...SWITCH, PUSH (AC POWER)	
T601	△.1-447-371-00	(US,Canadian)...TRANSFORMER, POWER	
T601	△.1-447-372-00	(AEP,GAEP,UK)...TRANSFORMER, POWER	
T601	△.1-447-373-00	(E).....TRANSFORMER, POWER	
X401	1-527-979-00	OSCILLATOR, CERAMIC	

The components identified by shading and mark △ are critical for safety. Replace only with part number specified.

Les composants identifiés par une trame et une marque △ sont critiques pour la sécurité. Ne les remplacer que par une pièce portant le numéro spécifié.

ELECTROLYTIC CAPACITORS

CAP. (μF)	RATING → : Use the high voltage rated one.					
	6.3 VOLT.	10 VOLT.	16 VOLT.	25 VOLT.	35 VOLT.	50 VOLT.
	PART No.	PART No.	PART No.	PART No.	PART No.	PART No.
0.47					→	1-121-726-00
1.0					→	1-121-391-00
2.2					→	1-121-450-00
3.3	→	→	→	1-121-392-00	→	1-121-393-00
4.7	→	→	→	1-121-395-00	→	1-121-396-00
10	→	→	1-121-651-00	1-121-398-00	→	1-121-738-00
22	→	→	1-121-479-00	1-121-480-00	1-121-662-00	1-121-152-00
33	→	→	1-121-403-00	1-121-404-00	1-121-652-00	1-121-405-00
47	→	1-121-352-00	1-121-409-00	1-121-410-00	1-121-653-00	1-121-411-00
100	→	1-121-414-00	1-121-415-00	1-121-416-00	1-121-357-00	1-121-417-00
220	1-121-419-00	1-121-420-00	1-121-421-00	1-121-422-00	1-121-261-00	1-121-423-00
330	1-121-751-00	1-121-805-00	1-121-521-00	1-121-654-00	1-121-655-00	1-121-656-00
470	1-121-424-00	1-121-425-00	1-121-426-00	1-121-733-00	1-121-361-00	1-121-810-00
1000		1-121-736-00	1-121-245-00	1-121-657-00	1-121-388-00	1-123-061-00
2200	1-121-658-00	1-121-659-00	1-121-660-00	1-123-067-00	1-121-984-00	-
3300	1-121-661-00	1-123-075-00	1-123-071-00	-	-	-

CAP. (μF)	100 VOLT.	160 VOLT.	250 VOLT.	350 VOLT.
	PART No.	PART No.	PART No.	PART No.
0.47		-		
1.0	1-123-249-00	1-123-252-00	1-123-003-00	1-121-168-00
2.2	1-123-250-00	1-123-026-00	-	1-123-028-00
3.3	1-121-995-00	-	1-123-004-00	1-123-006-00
4.7	1-123-255-00	1-121-246-00	1-121-759-00	1-123-007-00
10	1-121-126-00	1-121-999-00	1-123-254-00	1-123-008-00
22	1-121-996-00	1-123-253-00	1-123-005-00	1-123-022-00
33	1-121-997-00	1-121-757-00	-	-
47	1-123-251-00	1-121-919-00	-	-
100	1-123-084-00	-	-	-

CERAMIC CAPACITORS

RATING							
CAP. (pF)	50 VOLT.	CAP. (pF)	50 VOLT.	CAP. (pF)	50 VOLT.	CAP. (μF)	50 VOLT.
	PART No.		PART No.		PART No.		PART No.
0.5	1-101-837-00	22	1-102-959-00	150	1-101-361-00	0.001	1-102-074-00
0.75	1-101-586-00	24	1-102-960-00	160	1-101-367-00	0.0012	1-102-118-00
1.0	1-102-934-00	27	1-102-961-00	180	1-102-976-00	0.0015	1-102-119-00
1.5	1-101-576-00	30	1-102-962-00	200	1-102-977-00	0.0018	1-102-120-00
2.0	1-102-935-00	33	1-102-963-00	220	1-102-978-00	0.0022	1-102-121-00
3	1-102-936-00	36	1-102-964-00	240	1-102-979-00	0.0027	1-102-122-00
4	1-102-937-00	39	1-102-965-00	270	1-102-980-00	0.0033	1-102-123-00
5	1-102-942-00	43	1-102-966-00	300	1-102-981-00	0.0039	1-102-124-00
6	1-102-943-00	47	1-101-880-00	330	1-102-820-00	0.0047	1-102-125-00
7	1-102-944-00	51	1-101-882-00	360	1-102-821-00	0.0056	1-102-126-00
8	1-102-945-00	56	1-101-884-00	390	1-102-822-00	0.0068	1-102-127-00
9	1-102-946-00	62	1-101-886-00	430	1-102-823-00	0.0082	1-102-128-00
10	1-102-947-00	68	1-101-888-00	470	1-102-824-00	0.01	1-102-129-00
11	1-102-948-00	75	1-101-890-00	510	1-101-059-00	0.022	1-101-005-00
12	1-102-949-00	82	1-102-971-00	560	1-102-115-00	0.047	1-101-006-00
13	1-102-950-00	91	1-102-972-00	680	1-102-116-00		
15	1-102-951-00	100	1-102-973-00	820	1-102-117-00		
16	1-102-952-00	110	1-102-815-00				
18	1-102-953-00	120	1-102-816-00				
20	1-102-958-00	130	1-101-081-00				

0.001μF = 1,000pF

CERAMIC (SEMICONDUCTOR) CAPACITORS

RATING → : Use the high voltage rated one.					
CAP. (μF)	25 VOLT.	50 VOLT.	CAP. (μF)	25 VOLT.	50 VOLT.
	PART No.	PART No.		PART No.	PART No.
0.001	→	1-161-039-00	0.018	1-161-016-00	1-161-054-00
0.0012	→	1-161-040-00	0.022	1-161-017-00	1-161-055-00
0.0015		1-161-041-00	0.027	1-161-018-00	1-161-056-00
0.0018		1-161-042-00	0.033	1-161-019-00	1-161-057-00
0.0022		1-161-043-00	0.039	1-161-010-00	1-161-058-00
0.0027	→	1-161-044-00	0.047	1-161-021-00	1-161-059-00
0.0033	→	1-161-045-00	0.056	→	1-161-060-00
0.0039	→	1-161-046-00	0.068	→	1-161-061-00
0.0047	→	1-161-047-00	0.082	1-161-024-00	1-161-062-00
0.0056	→	1-161-048-00	0.1	1-161-025-00	1-161-063-00
0.0068	→	1-161-049-00			
0.0082	1-161-012-00	1-161-050-00			
0.01	1-161-013-00	1-161-051-00			
0.012	→	1-161-052-00			
0.015	1-161-015-00	1-161-053-00			

MYLAR CAPACITORS

CAP. (μF)	RATING			CAP. (μF)	RATING			CAP. (μF)	RATING		
	50 VOLT.	100 VOLT.	200 VOLT.		50 VOLT.	100 VOLT.	200 VOLT.		50 VOLT.	100 VOLT.	200 VOLT.
	PART No.	PART No.	PART No.		PART No.	PART No.	PART No.		PART No.	PART No.	PART No.
0.001	1-108-227-00	1-108-365-00	1-108-409-00	0.01	1-108-239-00	1-108-377-00	1-108-421-00	0.1	1-108-251-00	1-108-389-00	1-108-433-00
0.0012	1-108-351-00	1-108-366-00	1-108-410-00	0.012	1-108-357-00	1-108-378-00	1-108-422-00	0.12	1-108-363-00	1-108-390-00	1-108-434-00
0.0015	1-108-228-00	1-108-367-00	1-108-411-00	0.015	1-108-240-00	1-108-379-00	1-108-423-00	0.15	1-108-252-00	1-108-391-00	1-108-435-00
0.0018	1-108-352-00	1-108-368-00	1-108-412-00	0.018	1-108-358-00	1-108-380-00	1-108-424-00	0.18	1-108-364-00	1-108-392-00	1-108-436-00
0.0022	1-108-230-00	1-108-369-00	1-108-413-00	0.022	1-108-242-00	1-108-381-00	1-108-425-00	0.22	1-108-254-00	1-108-393-00	1-108-437-00
0.0027	1-108-353-00	1-108-370-00	1-108-414-00	0.027	1-108-359-00	1-108-382-00	1-108-426-00	0.27	1-108-854-00	-	-
0.0033	1-108-232-00	1-108-371-00	1-108-415-00	0.033	1-108-244-00	1-108-383-00	1-108-427-00	0.33	1-108-855-00	-	-
0.0039	1-108-354-00	1-108-372-00	1-108-416-00	0.039	1-108-360-00	1-108-384-00	1-108-428-00	0.39	1-108-856-00	-	-
0.0047	1-108-234-00	1-108-373-00	1-108-417-00	0.047	1-108-246-00	1-108-385-00	1-108-429-00	0.47	1-108-857-00	-	-
0.0056	1-108-355-00	1-108-374-00	1-108-418-00	0.056	1-108-361-00	1-108-386-00	1-108-430-00				
0.0068	1-108-237-00	1-108-375-00	1-108-419-00	0.068	1-108-249-00	1-108-387-00	1-108-431-00				
0.0082	1-108-356-00	1-108-376-00	1-108-420-00	0.082	1-108-362-00	1-108-388-00	1-108-432-00				



TANTALUM CAPACITORS

CAP. (μF)	RATING						
	3.15 VOLT.	6.3 VOLT.	10 VOLT.	16 VOLT.	20 VOLT.	25 VOLT.	35 VOLT.
	PART No.	PART No.	PART No.	PART No.	PART No.	PART No.	PART No.
0.01					→	→	1-131-396-00
0.015					→	→	1-131-397-00
0.022					→	→	1-131-398-00
0.033					→	→	1-131-399-00
0.047					→	→	1-131-400-00
0.068					→	→	1-131-401-00
0.1					→	→	1-131-402-00
0.15					→	→	1-131-403-00
0.22					→	→	1-131-404-00
0.33					→	1-131-409-00	1-131-405-00
0.47	-	-	-	-	1-131-412-00	→	1-131-406-00
0.68	-	-	-	1-131-415-00	→	1-131-410-00	1-131-407-00
1.0	-	-	1-131-418-00	-	1-131-413-00	→	1-131-408-00
1.5	-	1-131-421-00	-	1-131-416-00	→	1-131-411-00	1-131-348-00
2.2	1-131-424-00	-	1-131-419-00	-	1-131-414-00	1-131-355-00	1-131-349-00
3.3	-	1-131-422-00	-	1-131-417-00	1-131-362-00	1-131-356-00	1-131-350-00
4.7	1-131-425-00	-	1-131-420-00	1-131-369-00	1-131-363-00	1-131-357-00	1-131-351-00
6.8	-	1-131-423-00	1-131-376-00	1-131-370-00	1-131-364-00	1-131-358-00	1-131-352-00
10	1-131-426-00	1-131-383-00	1-131-377-00	1-131-371-00	1-131-365-00	1-131-359-00	1-131-353-00
15	1-131-390-00	1-131-384-00	1-131-378-00	1-131-372-00	1-131-366-00	1-131-360-00	-
22	1-131-391-00	1-131-385-00	1-131-379-00	1-131-373-00	1-131-367-00		
33	1-131-392-00	1-131-386-00	1-131-380-00	1-131-374-00			
47	1-131-393-00	1-131-387-00	1-131-381-00				
68	1-131-394-00	1-131-388-00					
100	1-131-395-00						



TANTALUM CAPACITORS

CAP. (μF)	RATING					
	3 VOLT.	6.3 VOLT.	10 VOLT.	16 VOLT.	20 VOLT.	35 VOLT.
	PART No.	PART No.	PART No.	PART No.	PART No.	PART No.
0.033						1-131-273-00
0.047						1-131-274-00
0.068						1-131-275-00
0.1						1-131-276-00
0.15						1-131-277-00
0.22						
0.33					1-131-262-00	1-131-278-00
0.47					1-131-263-00	1-131-279-00
0.68			1-131-169-00		1-131-264-00	1-131-280-00
1.0				1-131-258-00	1-131-265-00	1-131-281-00
1.5		1-131-250-00			1-131-266-00	1-131-282-00
2.2					1-131-267-00	1-131-283-00
3.3				1-131-259-00	1-131-268-00	1-131-284-00
4.7		1-131-251-00	1-131-255-00		1-131-269-00	
6.8			1-131-171-00		1-131-270-00	
10				1-131-260-00	1-131-271-00	
15			1-131-256-00		1-131-272-00	
22		1-131-252-00		1-131-261-00		
33	1-131-176-00		1-131-257-00			
47	1-131-288-00	1-131-253-00	1-131-173-00			
100	1-131-177-00	1-131-174-00				

1/4 WATT CARBON RESISTORS

Ω	Part No.	Ω	Part No.	Ω	Part No.	Ω	Part No.	Ω	Part No.	Ω	Part No.	Ω	Part No.
1.0	1-246-401-00	10	1-246-425-00	100	1-246-449-00	1.0k	1-246-473-00	10k	1-246-497-00	100k	1-246-521-00	1.0M	1-246-545-00
1.1	1-246-402-00	11	1-246-426-00	110	1-246-450-00	1.1k	1-246-474-00	11k	1-246-498-00	110k	1-246-522-00	1.1M	1-210-814-00
1.2	1-246-403-00	12	1-246-427-00	120	1-246-451-00	1.2k	1-246-475-00	12k	1-246-499-00	120k	1-246-523-00	1.2M	1-210-815-00
1.3	1-246-404-00	13	1-246-428-00	130	1-246-452-00	1.3k	1-246-476-00	13k	1-246-500-00	130k	1-246-524-00	1.3M	1-210-816-00
1.5	1-246-405-00	15	1-246-429-00	150	1-246-453-00	1.5k	1-246-477-00	15k	1-246-501-00	150k	1-246-525-00	1.5M	1-210-817-00
1.6	1-246-406-00	16	1-246-430-00	160	1-246-454-00	1.6k	1-246-478-00	16k	1-246-502-00	160k	1-246-526-00	1.6M	1-210-818-00
1.8	1-246-407-00	18	1-246-431-00	180	1-246-455-00	1.8k	1-246-479-00	18k	1-246-503-00	180k	1-246-527-00	1.8M	1-210-819-00
2.0	1-246-408-00	20	1-246-432-00	200	1-246-456-00	2.0k	1-246-480-00	20k	1-246-504-00	200k	1-246-528-00	2.0M	1-210-820-00
2.2	1-246-409-00	22	1-246-433-00	220	1-246-457-00	2.2k	1-246-481-00	22k	1-246-505-00	220k	1-246-529-00	2.2M	1-210-821-00
2.4	1-246-410-00	24	1-246-434-00	240	1-246-458-00	2.4k	1-246-482-00	24k	1-246-506-00	240k	1-246-530-00	2.4M	1-244-754-00
2.7	1-246-411-00	27	1-246-435-00	270	1-246-459-00	2.7k	1-246-483-00	27k	1-246-507-00	270k	1-246-531-00	2.7M	1-244-755-00
3.0	1-246-412-00	30	1-246-436-00	300	1-246-460-00	3.0k	1-246-484-00	30k	1-246-508-00	300k	1-246-532-00	3.0M	1-244-756-00
3.3	1-246-413-00	33	1-246-437-00	330	1-246-461-00	3.3k	1-246-485-00	33k	1-246-509-00	330k	1-246-533-00	3.3M	1-244-757-00
3.6	1-246-414-00	36	1-246-438-00	360	1-246-462-00	3.6k	1-246-486-00	36k	1-246-510-00	360k	1-246-534-00	3.6M	1-244-758-00
3.9	1-246-415-00	39	1-246-439-00	390	1-246-463-00	3.9k	1-246-487-00	39k	1-246-511-00	390k	1-246-535-00	3.9M	1-244-759-00
4.3	1-246-416-00	43	1-246-440-00	430	1-246-464-00	4.3k	1-246-488-00	43k	1-246-512-00	430k	1-246-536-00	4.3M	1-244-760-00
4.7	1-246-417-00	47	1-246-441-00	470	1-246-465-00	4.7k	1-246-489-00	47k	1-246-513-00	470k	1-246-537-00	4.7M	1-244-761-00
5.1	1-246-418-00	51	1-246-442-00	510	1-246-466-00	5.1k	1-246-490-00	51k	1-246-514-00	510k	1-246-538-00	5.1M	1-244-762-00
5.6	1-246-419-00	56	1-246-443-00	560	1-246-467-00	5.6k	1-246-491-00	56k	1-246-515-00	560k	1-246-539-00		
6.2	1-246-420-00	62	1-246-444-00	620	1-246-468-00	6.2k	1-246-492-00	62k	1-246-516-00	620k	1-246-540-00		
6.8	1-246-421-00	68	1-246-445-00	680	1-246-469-00	6.8k	1-246-493-00	68k	1-246-517-00	680k	1-246-541-00		
7.5	1-246-422-00	75	1-246-446-00	750	1-246-470-00	7.5k	1-246-494-00	75k	1-246-518-00	750k	1-246-542-00		
8.2	1-246-423-00	82	1-246-447-00	820	1-246-471-00	8.2k	1-246-495-00	82k	1-246-519-00	820k	1-246-543-00		
9.1	1-246-424-00	91	1-246-448-00	910	1-246-472-00	9.1k	1-246-496-00	91k	1-246-520-00	910k	1-246-544-00		

HARDWARE NOMENCLATURE

Screw:

P 3 x 10

L: Length in mm
D: Diameter in mm
Type of head

Indicated slotted-head only.

Unless otherwise indicated, it means cross-recessed head (Phillips type).

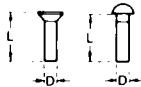

Nut, Washer, Retaining ring:

N 3

— Diameter of usable screw or shaft
— Reference designation

Reference Designation	Shape	Description	Remarks
SCREWS			
P		pan-head screw	binding-head (B) screw for replacement
PWH		pan-head screw with washer face	binding-head (B) screw and flat washer for replacement
PS PSP		pan-head screw with spring washer	binding-head (B) screw and spring washer for replacement
PSW PSPW		pan-head screw with spring and flat washers	binding-head (B) screw and spring and flat washers for replacement
R		round-head screw	binding-head (B) screw for replacement
K		flat-countersunk-head screw	
RK		oval-countersunk-head screw	
B		binding-head screw	
T		truss-head screw	binding-head (B) screw for replacement
F		flat-fillister-head screw	
RF		fillister-head screw	
BV		brazier-head screw	

Reference Designation	Shape	Description	Remarks
SELF-TAPPING SCREWS			
TA		self-tapping screw	ex: TA, P 3 x 10
PTP		pan-head self-tapping screw	binding-head self-tapping (TA, B) screw for replacement
PTPWH		pan-head self-tapping screw with washer face	binding-head self-tapping (TA, B) screw and flat washer for replacement
PTTWH		pan-head thread-rolling screw with washer face	binding-head (B) screw and flat washer for replacement
SET SCREWS			
SC		set screw	
SC		hexagon-socket set screw	ex: SC 2.6 x 4, hexagon socket
NUT			
N		nut	
WASHERS			
W		flat washer	
SW		spring washer	
LW		internal-tooth lock washer	ex: LW3, internal
LW		external-tooth lock washer	ex: LW3, external
RETAINING RINGS			
E		retaining ring	
G		grip-type retaining ring	

Sony Corporation

Audio & Video Group © 1982